

DREMEL®

Moto-Tool® Owner's Manual

Models 275, 285, 395,³ and 595

HONESTLY NOW . . . Have you read this
OWNER'S MANUAL?

This manual will tell you how to get the most out of your new Moto-Tool. It will give you tips on some of the many different do-it-yourself jobs the tool will perform around your home and workshop.

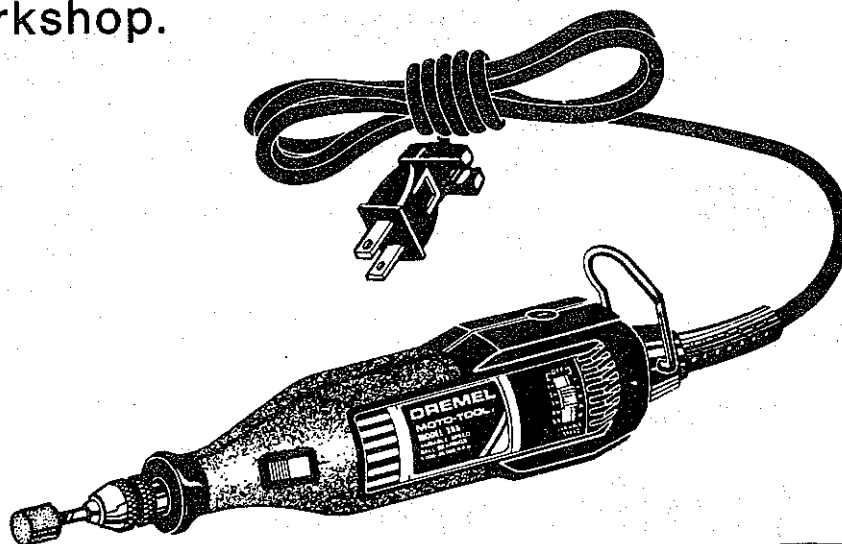

assembly • operation • safety instructions.

WARNING

For your own safety
read your
Owner's Manual
before operating
your
Dremel Moto-Tool

DREMEL®

P.O. Box 1468
Racine, Wisconsin 53401

For Your Safety.



When using electric tools, basic safety precautions should always be followed to reduce the risk of fire, electric shock, and personal injury, including the following:

READ AND SAVE ALL THE FOLLOWING INSTRUCTIONS:

1. Keep work area clean — Cluttered areas and benches invite injuries.

2. Avoid dangerous environment — Don't expose tools to rain. Don't use power tools in damp or wet locations. Don't use power tools in the presence of flammable liquids or gases. Avoid chemical or corrosive environments. Keep work area well lit.

3. Guard against electric shock — Prevent body contact with grounded surfaces. For example: pipes, radiators, refrigerator enclosures.

4. Keep children away — Do not let visitors contact tool or extension cord. All visitors should be kept away from work areas.

5. Store idle tools — When not in use, tools should be stored in dry, and high or locked-up place - out of reach of children.

6. Don't force tool — It will do the job better and safer at the rate for which it was intended.

7. Use right tool - Don't force small tool or attachment to do the job of a heavy-duty tool. Don't use tool for purpose not intended - for example - don't use circular saw for cutting tree limbs or logs.

8. Dress properly — Do not wear loose clothing or jewelry. They can be caught in moving parts. Rubber gloves and non-skid footwear are recommended when working outdoors. Wear protective hair covering to contain long hair.

9. Use safety glasses — Also use face or dust mask if cutting operation is dusty.

10. Don't abuse cord — Never carry tool by cord or yank it to disconnect from receptacle. Keep cord from heat, oil, and sharp edges.

11. Secure work — Use clamps or vise to hold work. It's safer than using your hand and it frees both hands to operate tool.

12. Don't over-reach — Keep proper footing and balance at all times.

13. Maintain tools with care — Keep tools sharp and clean for better and safer performance. Follow instructions for lubricating and changing accessories. Inspect tool cords periodically and if damaged, have repaired, by authorized service facility. Inspect extension cords periodically and replace if damaged. Keep handles dry, clean, and free from oil and grease.

14. Disconnect tools — When not in use, before servicing, and when changing accessories, such as blades, bits, cutters.

15. Remove adjusting keys and wrenches — Form habit of checking to see that keys and adjusting wrenches are removed from tool before turning it on.

16. Avoid unintentional starting — Don't carry plugged-in tool with finger on switch. Be sure switch is off when plugged in.

17. Outdoor use extension cords — When tool is used outdoors, use only extension cords intended for use outdoors and so marked.

18. Stay alert — Watch what you are doing. Use common sense. Do not operate tool

when you are tired. Don't use power tools after taking drugs, alcohol or medications.

19. Do not alter or misuse tool — These tools are precision built. Any alteration or modification not specified is misuse and may result in a dangerous condition.

20. Avoid gaseous areas — Do not operate portable electric tools in gaseous or explosive atmospheres. Motors in these tools normally spark, and the sparks might ignite fumes.

21 Check for damaged parts — before further use of the tool, check for damaged parts. Check for alignment of moving parts, binding of moving parts, breakage of parts, mounting, and any other conditions that may affect its operation. A part that is damaged should be properly repaired or replaced by authorized service center before further use of the tool. Have defective switches replaced by authorized service center. Do not use tool if switch does not turn it on and off.

22. Your tool is double insulated — And no grounding is necessary. The tool is equipped with a two wire cord and two prong plug which can be used in standard 120 volt A.C. outlets. Use only identical replacement parts when service is required.

23. EXTENSION CORDS - An undersized cord will cause a drop in line voltage, resulting in loss of power and over-heating. Use 18 gauge or heavier cord. **NOTE:** The smaller the gauge number, the heavier the cord. (Extension cords are available.)

24. WARNING: Use of damaged cords can shock, burn or electrocute.

READ AND SAVE ALL THE PRECEDING INSTRUCTIONS

Dremel Limited Warranty

Your Dremel product is warranty against defective material or workmanship for a period of one year from date of purchase. In the event of a failure of a product to conform to this written warranty, please take the following action:

1. DO NOT return your product to the place of purchase.
2. Carefully package the product by itself, with no other items, and return it freight prepaid, along with:
 - A. A copy of your dated proof of purchase (please keep a copy for yourself).
 - B. A written statement about the nature of the problem;
 - C. Your name, address and phone number to:

Dremel Service Center
4915 Twenty-First Street
Racine, Wisconsin 53406

OR

Dremel Service Center
4631 E. Sunny Dunes
Palm Springs, CA 92264

We recommend that the package be insured against loss or in transit damage for which we cannot be responsible.

This warranty applies only to the original registered purchaser. **DAMAGE TO THE PRODUCT RESULTING FROM TAMPERING, ACCIDENT, ABUSE, NEGLIGENCE, UNAUTHORIZED REPAIRS OR ALTERATIONS, UNAPPROVED ATTACHMENTS OR OTHER**

CAUSES UNRELATED TO PROBLEMS WITH MATERIAL OR WORKMANSHIP ARE NOT COVERED BY THIS WARRANTY.

No employee, agent, dealer or other person is authorized to give any warranties on behalf of Dremel. If Dremel inspection shows that the problem was caused by problems with material or workmanship within the limitations of the warranty, Dremel will repair or replace the product free of charge and return product prepaid. Repairs made necessary by normal wear or abuse, or repair for product outside the warranty period, if they can be made, will be charged at regular service prices.

DREMEL MAKES NO OTHER WARRANTY OF ANY KIND WHATSOEVER, EXPRESSED OR IMPLIED, AND ALL IMPLIED WARRANTIES OF MERCHANTABILITY AND FITNESS FOR A PARTICULAR PURPOSE WHICH EXCEED THE ABOVE MENTIONED OBLIGATION ARE HEREBY DISCLAIMED BY DREMEL AND EXCLUDED FROM THIS LIMITED WARRANTY.

This warranty gives you specific legal rights and you may also have other rights which vary from state to state. The obligation of the warrantor is solely to repair or replace the product. The warrantor is not liable for any incidental or consequential damages due to any such alleged defect. Some states do not allow the exclusion or limitations of incidental or consequential damages, so the above limitations or exclusion may not apply to you.

For prices and warranty fulfillment in the continental United States, contact your local Dremel distributor.

Introduction

The Moto-Tool is a handful of high-speed power. It serves as a carver, a grinder, polisher, sander, cutter, power brush, drill and more.

The Moto-Tool has a small, powerful electric motor, is comfortable in the hand, and is made to accept a large variety of accessories including abrasive wheels, drill bits, wire brushes, polishers, engraving cutters, router bits, and cutting wheels. Accessories come in a variety of shapes and permit you to do a number of different jobs. As you become familiar with the range of accessories and their uses, you will learn just how versatile the Moto-Tool is. You'll see dozens of uses you hadn't thought of before now.

The real secret of the Moto-Tool is its speed. To understand the advantages of its high speed, you have to know that the standard portable electric drill runs at speeds up to 2,800 revolutions per minute. The Moto-Tool operates at speeds up to 30,000 revolutions per minute. The typical electric drill is a low-speed, high torque tool; the Moto-Tool is just the opposite — a high-speed, low torque tool. The chief difference to the user is that in the high speed tools, the speed combined with the accessory mounted in the chuck does the work. You don't apply pressure to the tool, but simply hold and guide it. In the low speed tools, you not only guide the tool, but also apply pressure to it, as you do, for example, when drilling a hole.

It is this high speed, along with its compact size and wide variety of special accessories, that makes the Moto-Tool different from other power tools. The speed enables it to do jobs low-speed tools cannot do, such as cutting hardened steel, engraving glass, etc.

Getting the most out of your Moto-Tool is a matter of learning how to let this speed work for you.

You should not think of the Moto-Tool as a small version of a standard electric drill. While it does do some of the same jobs as an electric drill, it is basically different in concept, design and use. Craftsmen who have used it for years think of it as "a special tool for special jobs", and as "the tool that does jobs which others don't."

For example, if you want to cut a neat 2-inch square hole in a furnace duct, the Moto-Tool will do the job quickly and easily. Practically no other tool will. Or if a door is slightly misaligned because the house settled, the latch bolt may no longer enter the strike plate properly, making the door difficult to close or lock. Use the Moto-Tool to cut away just enough of the strike plate so that the latch bolt operates properly. You can do it in minutes. There are literally hundreds of special applications such as these for the Moto-Tool in every home.

In addition to these special applications, think of the Moto-Tool for shaping or removing wood, metal and plastics. This is how wood carvers use the tool, and while you may not be interested in wood carving, there are many times when you want to cut a recess, round a sharp corner, or enlarge an opening.

And then there are grinding and polishing jobs done by the Moto-Tool. You can sharpen tools, scissors and cutlery, get rid of burrs and unwanted sharp edges, accumulated rust, grind new shapes, etc.

The point is to think of the Moto-Tool for the many jobs it can do because of its own unique properties and capabilities. When you have a job to do, think of the Moto-Tool as one possible solution.



Rout Wood

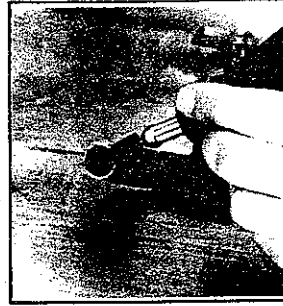

Deburr Metal



Engrave Glass

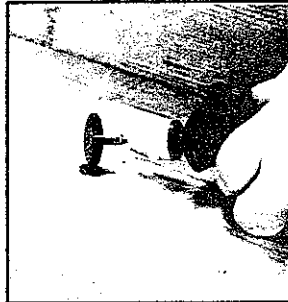

Slot Screw Head



Cut Rusted Nut

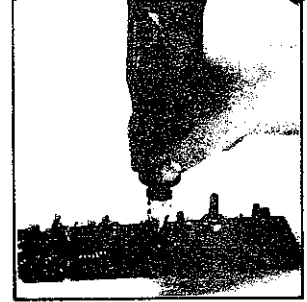

Precise Drilling



Cut Pipe



Sharpen Tools



Shape Wood



Polish Brass



Carve Wood

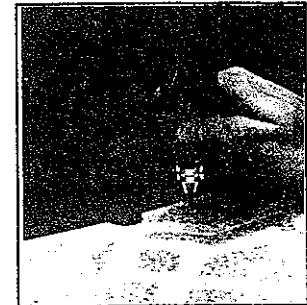

Shape Tile

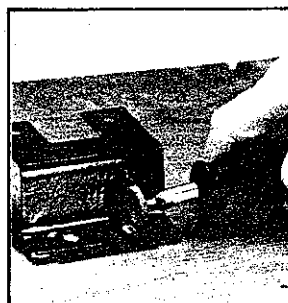

Grind Rivet

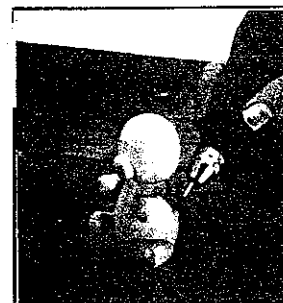

Delicate Sanding

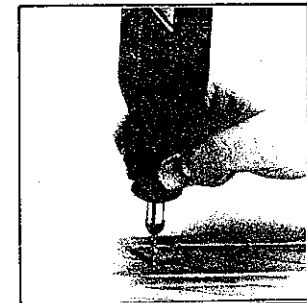

Drill Hardwood

Operation Guidelines

Read the next sections carefully. They will help you use your Moto-Tool correctly and help you select the correct accessory for your job.

Using the Moto-Tool

The first step in learning to use the Moto-Tool is to get the "feel" of it. Hold it in your hand and feel its weight and balance. Feel the taper of the housing. This taper permits the Moto-Tool to be grasped much like a pen or pencil. If you have a variable speed model, turn it on by sliding the switch speed indicator to each of the speed settings (1 thru 5), allowing the tool to maintain full speed at each setting. If you have a two-speed model, turn it on by sliding the switch indicator to the LOW speed setting. You will notice a detent at this setting. Then slide the switch indicator to the HIGH speed setting. You will also notice a detent at this setting. If you have a single speed model, turn it on by sliding the switch indicator to the on position, you will also notice a detent at this setting.

When you turn on the tool for the first time, hold it away from your face. Accessories can be damaged during handling, and can fly apart as they come up to speed. This is not common, but it does happen.

Practice on scrap materials first to see how the Moto-Tool cuts. Keep in mind that the work is done by the speed of the tool and by the accessory in the chuck. You should not lean on or push the tool into the work.

Instead, lower the spinning accessory lightly to the work and allow it to touch the point at which you want cutting (or sanding or etching, etc.) to begin. Concentrate on guiding the tool over the work using very little pres-

sure from your hand. Allow the accessory to do the work.

Usually, it is best to make a series of passes with the tool rather than attempt to do all the work in one pass. To make a cut, for example, pass the tool back and forth over the work, much as you would a small paint brush. Cut a little material on each pass until you reach the desired depth. For most work, the deft, gentle touch is best. With it, you have the best control, are less likely to make errors, and will get the most efficient work out of the accessory.

The pencil grip we described is one way to hold the Moto-Tool. A second way to grip the tool much as you would the handgrip on a bicycle, with your hand wrapped around the housing and the chuck extending just beyond your thumb and forefinger. This grip must be used for cutoff wheels and saws for maximum control and is often used with polishing, brushing, and grinding accessories.

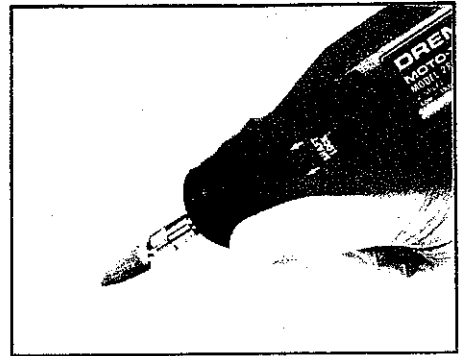

For best control in close work, grip the Moto-Tool like a pencil between your thumb and forefinger.

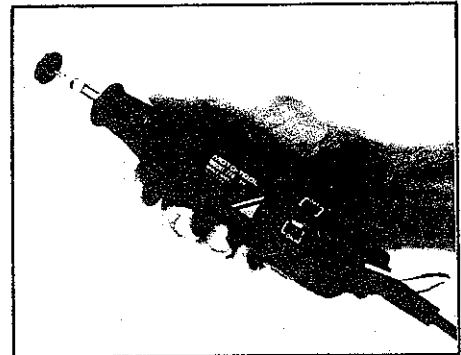

This is the "handgrip" method of holding the tool used for operations such as grinding a flat surface.

WARNING When using cutoff wheels (Nos. 409, 420, 426) and high speed cutters (Nos. 198, 199) always have the work securely clamped. Never attempt to hold the work with one hand while using either of these accessories. The reason is that these wheels will grab if they become slightly canted in the groove, and can kick-back causing loss of control resulting in serious injury. Your second hand should be used to steady and guide the hand holding the tool. When a cutoff wheel grabs, the wheel itself usually breaks.



The operation of any power tool can result in foreign objects being thrown into the eyes, which can result in severe eye damage. Always wear safety glasses or eye shields before commencing power tool operation. We recommended Wide Vision Safety Mask for use over spectacles or standard safety glasses.

Whenever you hold the tool, be careful not to cover the air vents with your hand. This blocks the air flow and causes the motor to overheat.

ALWAYS UNPLUG MOTO-TOOL BEFORE CHANGING ACCESSORIES, CHANGING COLLETS OR SERVICING YOUR MOTO TOOL.

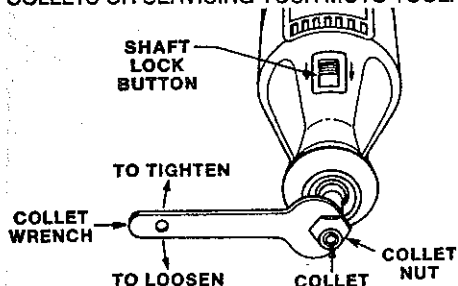

COLLET — Consists of a collet nut and collet. To loosen, first slide shaft lock forward and rotate the shaft by hand until the lock engages the shaft preventing further rotation.

(NOTE: Do not engage lock while the Moto-Tool is running.) With the lock engaged use the collet wrench to loosen the collet nut. Change accessories inserting the new one into the collet as far as possible to minimize runout and unbalance. With the lock engaged, tighten the collet nut with the wrench until the accessory shank is gripped by the collet. Avoid excessive tightening of the collet nut. This means of securing accessories is best when using the same bit for extended periods or during heavy material removal applications.

COLLETS — Four different size collets (see illustration), to accommodate different shank

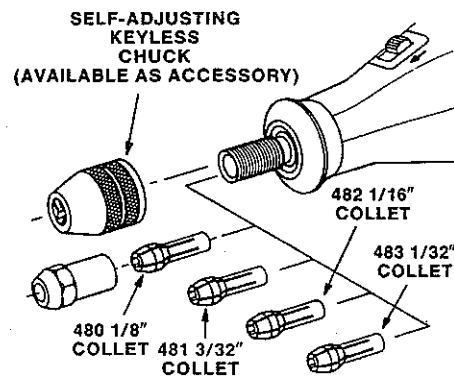

sizes, are available for your Moto-Tool. To install a different collet, remove the collet nut and remove the old collet. Insert the unslotted end of the collet in the hole in the end of the tool shaft. Replace collet nut on the shaft. Always use the collet which matches the shank size of the accessory you plan to use. Never force a larger diameter shank into a collet.

KEYLESS CHUCK — Remove collet and the keyless chuck can be threaded on the end of the shaft by engaging the shaft lock button, you need only use hand tightening to secure an accessory. Use the keyless chuck when there is a need to change bits frequently, for light duty jobs.

BALANCING ACCESSORIES — For precision work, it is important that all accessories be in good balance (much the same as the tires on your automobile). To true up or balance an accessory, slightly loosen collet nut and give the accessory or collet a 1/4" turn. Retighten collet nut and run the Moto-Tool. You should be able to tell by the sound and feel if your accessory is running in balance. Continue adjusting in this fashion until best balance is achieved. To maintain balance on abrasive wheel points, before each use, with the wheel point secured in the collet, turn on the Moto-Tool and run the 415 Dressing Stone lightly against the revolving wheel point. This removes high spots and trues up the wheel point for good balance.

WHEEL DIAMETER — Other than the No. 426 cutoff wheel, do not use grinding wheels over 1" in diameter. Moto-Tool's high speed can cause larger wheels to fly apart and could cause injury.

SAFETY — Protect your eyes when grinding or routing with the Moto-Tool... always wear an approved type of safety glasses.

Remember, your new Dremel Moto-Tool is the finest power tool of its kind. But its performance is only as good as the accessories with which it is used. "We recommend only Dremel accessories to be used." "Use of any other accessories may create a hazard." We hope you'll enjoy many years of trouble free pleasure from your Dremel Moto-Tool.

Operating Speeds & Accessories

Set the speed indicator to fit the job - To achieve the best job results when working with different materials, the speed of the Moto-Tool should be regulated. Only a full wave output speed control such as the Dremel Models 217 and 219 should be used with the Model 275. Models 285, 395, and 595 Moto-Tools have an integral speed control and an external speed control should never be used with these tools.

To select the right speed for each job, use a practice piece of material. Vary speed to find the best speed for the accessory you are using and the job to be done.

There are three basic types of Moto-Tools: single speed, two-speed and variable speed models. On the single speed model, there is an ON-OFF switch. When the switch is on, the tool runs at 28,000 RPM. On the two-speed model, there is a LO and HI switch. When the switch indicator is on the low setting, the tool runs at about 15,000 RPM. When the switch indicator is on the high setting the tool runs about 28,000 RPM. On the variable speed model, there is a switch indicator; with a white line on it. Slide to the number on the housing to select the operating speed needed from 5,000 — 30,000 R.P.M. You can refer to the charts on page 6 to determine the proper speed, based on the material being worked and the type of cutter or other accessory being used. These charts enable you to select both the correct accessory and the optimum speed at a glance.

If you have a single speed or two-speed model, you will be able to use many accessories to do a wide assortment of jobs. For the majority of applications, all models of the Moto-Tool should be used at top speed.

Needs for Slower Speeds

However, certain materials (some plastics, for example) require a relatively slow speed because at high speed the friction of the tool generates heat and causes the plastic to melt.

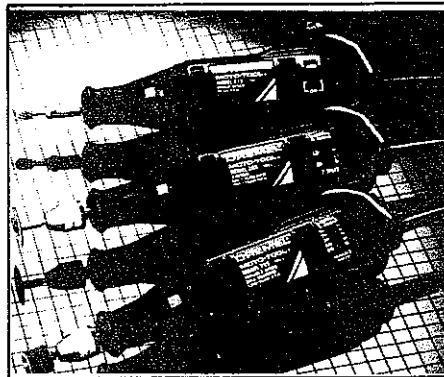

Most work is done at top speed on all Moto-Tool models. Lower speeds are needed only for certain tasks.

Slow speeds (15,000 RPM or less) usually are best for polishing operations employing the felt polishing accessories. They may also be best for working on delicate projects as "eggery" work, delicate wood carving, and fragile model parts. You should always do polishing with wire brush accessories at slower speeds and never higher than 15,000 RPM.

Higher speeds are better for carving, cutting, routing, shaping, cutting dados or rabbets in wood.

Hardwoods, metals, and glass require high speed operation, and drilling should also be done at high speeds.

The speed of Models 395 and 595 is controlled by setting this indicator on the housing.

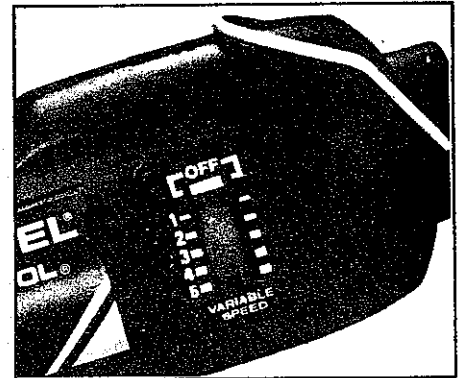

The Settings for Approximate Revolutions Per Minute Moto-Tool Variable Speed Models 395, and 595.

Switch Setting	Speed Range
1	4,500- 8,000 RPM
2	9,000-11,000 RPM
3	12,000-17,000 RPM
4	18,000-24,000 RPM
5	25,000-30,000 RPM

NOTE: Speed is affected by voltage changes. A reduced incoming voltage will slow the R.P.M. of the tool, especially at the lowest setting. If your tool appears to be running slow increase the speed setting accordingly.

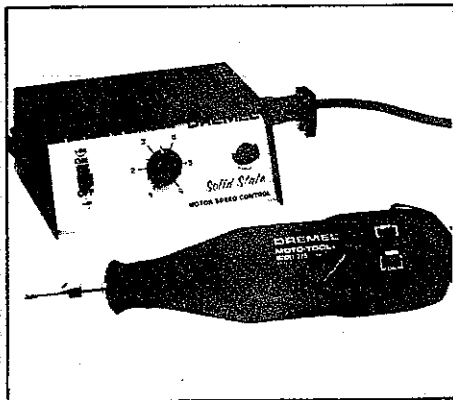

If you choose, dial the speed you need on the single speed model 275 with this table-top control accessory.

Dial Settings for Approximate Revolutions Per Minute, using the No. 219 Manually Operated Speed Control with single speed Moto-Tools.

Dial Setting	Speed Range
1	500 RPM
2	4,000 RPM
3	12,000 RPM
4	22,000 RPM
5	28,000 RPM

(Note: You can dial intermediate settings. For example, a dial setting of 2-1/2 would produce a motor speed of approximately 8,000 RPM.)

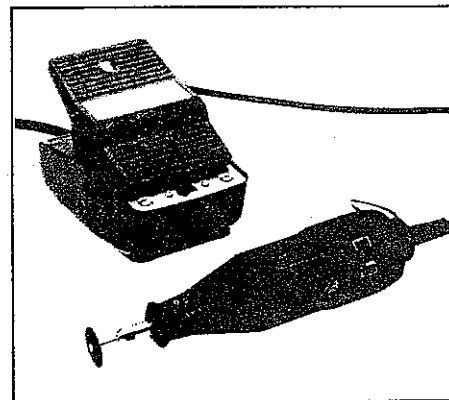

If you need it, single-speed models also can have speed control by the addition of a foot control unit.

The point to remember is this: You can do the great majority of work with the single speed at its regular speed of 28,000 RPM. But for certain materials and types of work, you need slower speeds - which is the reason the variable speed models and the speed control units were developed.

To aid you in determining the optimum operational speed for different materials and different accessories, we have constructed a series of tables that appear on page 6. By referring to these tables, you can discover the recommended speeds for each type of accessory. Look these tables over and become familiar with them.

Ultimately, the best way to determine the correct speed for work on any material is to practice for a few minutes on a piece of scrap, even after referring to the chart. You can quickly learn that a slower or faster speed is more effective just by observing what happens as you make a pass or two at different speeds. When working with plastic, for example, start at a slow rate of speed and increase the speed until you observe that the plastic is melting at the point of contact. Then back the speed off slightly to get the optimum working speed.

Some rules of thumb in regard to speed:

1. Plastic and materials that melt at low temperatures should be cut at low speeds.
2. Polishing, buffing and cleaning with a wire brush should be done at speeds below 15,000 RPM to prevent damage to the brush.
3. Soft wood should be cut at high speed.
4. Iron or steel should be cut at top speed if using a tungsten carbide accessory, but at slower speeds if using high speed steel cutters. If a high speed steel cutter starts to chatter - this normally means it is running too slow.
5. Aluminum, copper alloys, lead alloys, zinc alloys, and tin may be cut at any speed, depending on the type of cutting being done. Use paraffin or other suitable lubricant on the cutter to prevent the cut material from adhering to the cutter teeth.

Increasing the pressure on the tool is not the answer when it is not cutting as you think it should. Perhaps you should be using a different cutter, and perhaps an adjustment in speed would solve the problem. But leaning on the tool seldom helps.

Speed Settings

* Speed for light cuts, caution burning on deep grooves.
 † Depending on cutting direction relative to grain.

CATALOG NUMBER	SOFT WOOD	HARD WOOD	LAMINATES PLASTIC	STEEL	ALUMINUM, BRASS, ETC.	SHELL/ STONE	CERAMIC	GLASS
HIGH SPEED CUTTERS								
100, 121, 131, 141	5	5	3	2	4			
114, 124, 134, 144	5	3	2	1-2	2			
189, 190	5	5	2	4	5			
118, 191, 193	5	5	2	3	5			
192, 194	5	5	2	3	5			
116, 117, 125, 196	5	3	2	2	2			
115, 178	5	5	2	1-2	1-2			
197	4	2	2	1	3			
198	4	2	2	2	3			
199	4	2	1-2	2	2			
SMALL ENGRAVING CUTTERS								
105, 108	5	5	4	4	3			
106, 109	5	5	3	4	3			
107, 110	5	5	3	4	2			
111	5*	5*	4*	4	3			
112	5*	5*	3*	4	3			
113	5*	5*	3*	4	2			
RUBBER POLISHING POINT								
Acc Set 201				2	1	1		
Acc Set 202						1	1	
425, 427				2	1			
CUTTING ACCESSORIES — SEE WARNING PAGE 7								
400	5	5						
406	5	5						
409, 420, 426				5				
HIGH SPEED ROUTER BITS								
610	3	3						
612, 613, 614, 632, 640	3	2†						
650, 652	5	5†						
654	5	2†						
DIAMOND WHEEL POINTS								
7103, 7105, 7117, 7120, 7122, 7123, 7134, 7144								
ALUMINUM OXIDE GRINDING STONES								
915, 923, 924, 945, 997, 8153			1		3	1/3		
913, 914, 943, 953, 954, 963, 964, 974, 992 8160, 8162, 8163			1		1-2	1/1		
904, 922, 932 941, 952, 984 8173, 8174, 8175			1		1-2	1/1		
911, 921, 962 973, 8184			1		1	1/1		
903, 971, 8193			1		1	1/1		
981, 8200, 8202			1		1	1/1		
8215			1		1	1/1		
SILICON CARBIDE GRINDING STONES								
83322, 83642, 83702, 86442					2	1	2	2
83142, 84382					2	1	2	1
84922					1-2	1	2	1-2
85422					1	1	2	1
85562					2	1	2	1
85342, 85602					2	1	2	1
85622					2	1	2	1
TUNGSTEN CARBIDE CUTTERS								
9901, 9902, 9903, 9904, 9905, 9906, 9912	4	4	1	2	3			
9907, 9908, 9909, 9910, 9911	5	5	1	2	3			

Moto-Tool Accessories

The number and variety of accessories for the Moto-Tool are almost limitless. There is a category suited to almost any job you might have to do—and a variety of sizes and shapes within each category which enables you to get the perfect accessory for every need.

Refer to the DREMEL BITS OF INFORMATION ACCESSORY ORDER FORM for illustrations of the accessories available. These accessories may be found at your local hardware, hobby or home center dealers.

Collets



If you expect to use a variety of accessories, we recommend that in the beginning you purchase a complete set of four collets. Store these so that you will have the proper size of collet for any accessory or drill bit you want to use. Currently, the 1/8" and 3/32" collets accommodate all of the available Dremel accessories.

Mandrels

A mandrel is a shank with a threaded or screw head, and mandrels are required when you use polishing accessories, cutting wheels, sanding discs, and polishing points. The reason mandrels are used is that sanding discs, cutting wheels and similar accessories must be replaced frequently. The mandrel is a permanent shank, allowing you to replace only the worn head when necessary, thus saving the expense of replacing the shaft each time.

Screw Mandrel No. 401

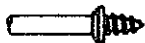

This is a screw mandrel used with the felt polishing tip and felt polishing wheels

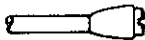

Small Screw Mandrel No. 402

This is a mandrel with a small screw at its tip, and is used with emery cutting wheels, sanding discs, and polishing wheels.



Threaded Tip Mandrel No. 424

This is a mandrel with threaded tip which threads into the polishing point accessory No. 427.



High Speed Cutters

Available in 24 shapes, high speed cutters are used in carving, cutting, and slotting in wood, plastics, and soft metals such as aluminum, copper, and brass. These are the accessories to use for freehand routing or carving in wood or plastic, and for precision cutting.



Tungsten Carbide Cutters

These are tough, long-lived cutters for use on hardened steel, fired ceramics, and other very hard materials. They can be used for engraving on tools and garden equipment.

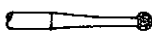

Small Engraving Cutters

This group has a wide variety of sizes and shapes, and are made for intricate work on ceramics (greenware), wood carvings, jewelry, and scrimshaw. They often are used in making complicated printed circuit boards. They should not be used on steel and other very

hard materials but are excellent on wood, plastic, and soft metals. Needs 3/32" collet.

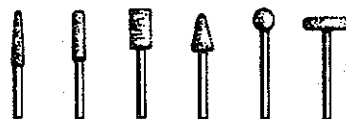

Structured Tooth Tungsten Carbide Cutters

Fast cutting, needle-sharp teeth for greater material removal, minimum loading. Use on fiberglass, wood, plastic, epoxy and rubber.

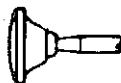

Aluminum Oxide Grinding Stones

Round, pointed, flat — you name the shape and there is one available in this category. These are made of aluminum oxide and cover virtually every possible kind of grinding application. Use them for sharpening lawn mowers blades, screwdriver tips, knives, scissors, chisels and other cutting tools. Use to remove flash from metal castings, deburring any metal after cutting, smoothing welded joints, grinding off rivets and removing rust. In machine shops, high speed drills and cutters normally are ground with aluminum oxide wheels.



Silicon Carbide Grinding Stones

Tougher than aluminum oxide points, these are made especially for use on hard materials such as glass and ceramics. Typical uses might be the removal of still marks and excess glaze on ceramics and engraving on glass.



Diamond Wheel Points

Excellent for fine detail work on wood, jade, ceramic, glass and other hard material. Bits are covered with diamond particles. 3/32" shanks.



Polishing Accessories

These include an impregnated polishing point and an impregnated polishing wheel for bringing metal surfaces to smooth finish; a felt polishing tip and felt polishing wheel, and cloth polishing wheel, all used for polishing plastics, metals, jewelry small parts. Also included in this group is a polishing compound (No. 421) for use with the felt and cloth polishers.

Polishing points make a very smooth surface, but a high luster is obtained using felt or cloth wheels and polishing compound.

No polishing compound is needed when using the 425 Polishing Wheel, 427 Polishing point.

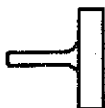

Aluminum Oxide Abrasive Wheels

Use to remove paint, deburr metal, polish stainless steel and other metals. Available in fine and medium grits.



Sanding Accessories

Sanding discs in fine, medium, and coarse grades are made to fit mandrel No. 402. They can be used for nearly any small sanding job you might have, from model making to fine furniture finishing. In addition, there is the drum sander, a tiny drum which fits into the Moto-Tool and makes it possible to shape wood, smooth fiberglass, sand inside curves and other difficult places, and other sanding jobs. You replace the sanding bands on the drum as they become worn and lose their grit. Bands come in fine and coarse grades.



Wire Brushes

Three different shapes of wire brushes are available. For best results wire brushes should be used at speeds not greater than 15,000 RPM. They remove rust from tools and other metal surfaces, and clean and burnish metal parts. Use for such jobs as cleaning electrical connections to assure good conduction.



Bristle Brushes

These are excellent cleaning tools on silverware, jewelry and antiques. The three shapes make it possible to get into tight corners and other difficult places. Bristle brushes can be used with polishing compound for faster cleaning or polishing.

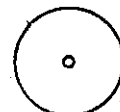

Cutting Wheels

These are thin discs of emery or fiberglass used for slicing, cutting off and similar operations. Use them for cutting off frozen bolt heads and nuts, or to reslot a screw head which has become so damaged that the screwdriver won't work in it. Fine for cutting BX cable, small rods, tubing, cable and cutting rectangular holes in sheet metal.

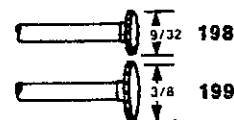

High Speed Cutters

Made of high quality steel. All have 1/8" shanks. Can be used for shaping, hollowing most metals, plastics and woods.

WARNING When using cutoff wheels (Nos. 409, 420, 426) and high speed cutters (Nos. 198, 199) always have the work securely clamped. Never attempt to hold the work with one hand while using either of these accessories. The reason is that these wheels will grab if they become slightly canted in the groove, and can kick-back causing loss of control resulting in serious injury. Your second hand should be used to steady and guide the hand holding the tool. When a cutoff wheel grabs, the wheel itself usually breaks.

Maintenance Information

MAINTENANCE OF REPLACEABLE BRUSHES Models 275, 285, 395, and 595.

The brushes should be inspected frequently when tools are used continuously. If your tool does not start, runs sporadically, loses power, makes unusual noises or runs at a reduced speed, check the brushes. To continue using the tool in this condition will permanently damage your tool.

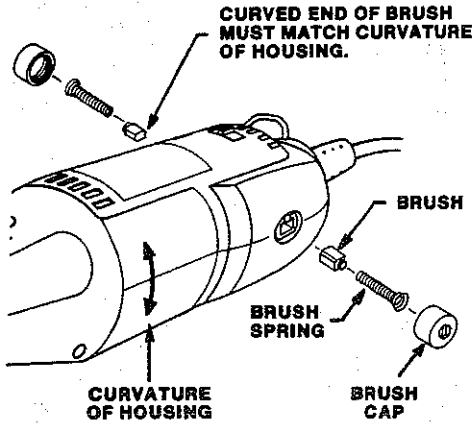

With the cord unplugged, remove the brush caps one at a time with a small screwdriver by rotating cap counter-clockwise and check each brush.

If the brush is less than 1/8" long and the end surface of the brush that contacts the commutator is rough and/or pitted, they should be replaced. Check both brushes. Usually the brushes will not wear out simultaneously. If one brush is worn out replace both brushes. Make sure the brushes are installed as illustrated. The curved surface of the brush must match the curvature of the housing.

After replacing brushes the tool should be run at no-load; place it on a clean surface and run it freely for 5 minutes before loading (or using) the tool. This will allow the brushes to "seat" properly and will give you more hours of life from each set of brushes. This will also extend the total life of your tool since the commutator surface will "wear" longer.

BEARINGS - Moto-Tools Nos. 275 and 285 are equipped with oil impregnated sleeve bearings. Model Nos. 395 and 595 have ball bearing construction. Under normal use neither type requires additional lubrication.

CAUTION:

Any servicing of this tool (Excluding brush replacement for Models 275, 285, 395, and 595) should be performed by an authorized service representative.

IMPORTANT!

Use of any accessories or attachments other than those supplied by Dremel may be hazardous.

Dremel Service Centers, 4915 Twenty-first St., Racine, WI 53406, or 4631 E. Sunny Dunes Palm Springs, CA 92264.

Moto-Tool Attachments

Add these Dremel attachments to your compact workshop and make your Moto-Tool more versatile.

Model 230 Router Attachment

Shapes, edges, chamfers, cuts, rabbets, dados, etc. Adjustable edges guide can be easily removed for freehand routing. The Model 230 can be used with Models 270, 280, 380 or 275, 285, 395, and 595.

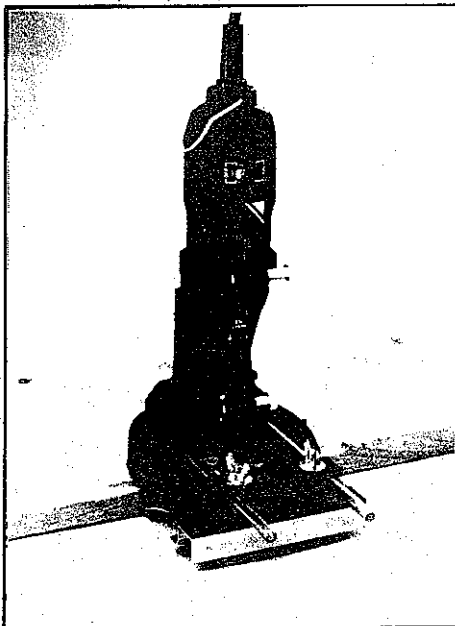

Model 225 Flex-Shaft

Allows finger-Tip control for tight corners and hard-to-reach areas. 36" long cable attaches to Moto-Tools 275, 285, 395, and 595. Pencil-like 1/2" diameter hand piece is cool-running, ideal for light duty wood carving and other uses.

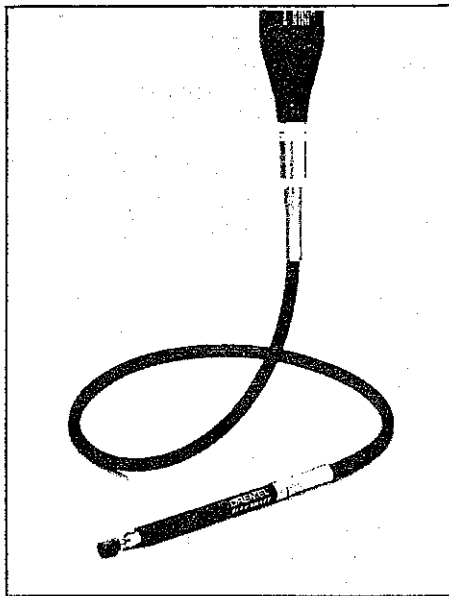

Model 212 Drill Press

For precision drilling, routing, grooving, 6" square work surface, 0" to 3" throat depth. Table slotted for guides, hold downs. Holds Moto-Tools 275, 285, 395, and 595 only.

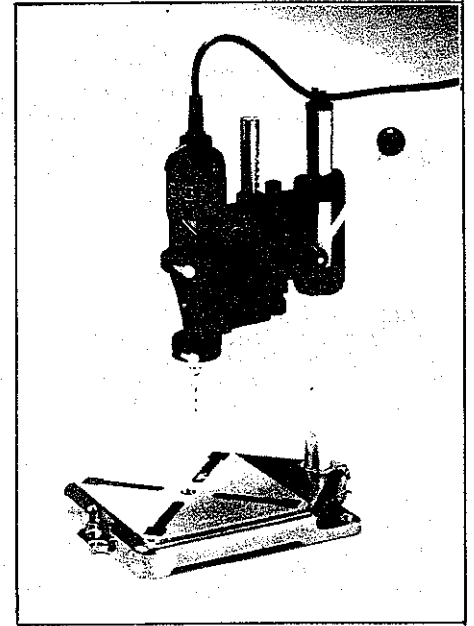

PARTS LIST MODEL 395 TYPE 3

CODE	PART NO	DESCRIPTION	PRICE	QTY	TOTAL
1	2615297355	Collet Nut	\$1.25		
2	2615000480	1/8" Collet - in tool	\$2.95		
2	2615000481	3/32" Collet **	\$2.95		
3	529484172	Housing Set N/A	N/A		
4	2615294311	Output Shaft Assembly N/A	N/A		
5	2615294309	Flex Coupling	\$1.25		
6	2615294320	Armature & Coupling Assembly	\$24.25		
7	2615294039	Field Assembly N/A	N/A		
8	2615294304 (misc.)	Collet Lock & Spring	\$1.60		
9	2615090930	Brush & Spring (pair)	\$4.15		
10	2615294888	Switch Assembly	\$14.00		
11	2615294043	Hanger	\$0.65		
12	2615294041	Cord	\$5.80		
13	2615302205	Screws (4)	\$0.85		
14	2615990962	Wrench	\$1.40		
15	529480370	Screws (2) N/A	N/A		
17	2615294800	Housing Cap	\$1.48		
18	2615302217	Brush Cap - pair	\$1.60		
19	2615294308	Spline Driver	\$1.00		
			TOTAL		

QUESTIONS? CALL TOLL-FREE: 800-437-3635

Note: Number in "()" indicates the number of parts you will be shipped.

Prices subject to change without notice.

8/16/2006

DREMEL® MODEL 395 TYPE 3

(ALSO 595-3)

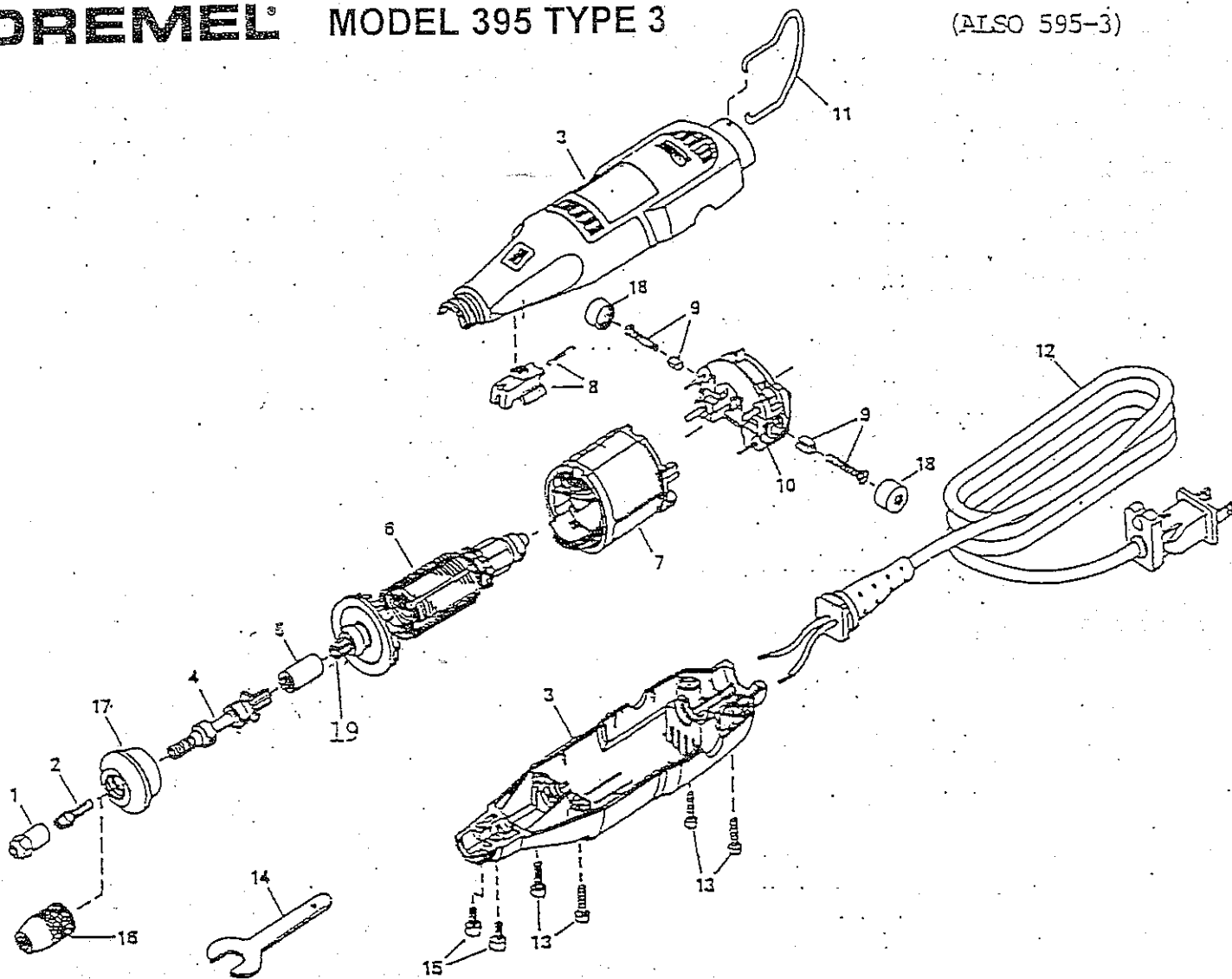

DREMEL SERVICE PARTS ORDER FORM

PHONE ORDERS - CUSTOMER SERVICE -
TECHNICAL ASSISTANCE

U.S.A.
WISCONSIN 1-800-437-3635
 1-262-554-1390
CALIFORNIA 1-800-275-2052
 1-760-327-3003

CANADA
ONTARIO 1-416-287-3000
 1-800-268-4255
QUEBEC 1-450-466-1173
B.C. 1-604-873-5394

TO ORDER BY FAX

WISCONSIN 1-262-554-7654
CALIFORNIA 1-760-322-3972
ONTARIO 1-416-287-3005
QUEBEC 1-450-466-8980
B.C. 1-604-873-5313

* Fax orders must include Visa/Mastercard or Discover number

TO ORDER BY MAIL

Dremel Service Center
 4915 21st Street
 Racine, WI 53406
 Monday-Friday 7 a.m. to 6 p.m. CST

Dremel Authorized Service
 4631 E. Sunny Dunes
 Palm Springs, CA 92264
 Monday-Friday 8:30 a.m to 5 p.m PST

Giles Tool Agencies
 47 Granger Avenue
 Scarborough ON M1K 3K9
 Monday-Friday, 8:30 a.m. to 5 p.m. EST

Dorson Ltd
 2071 Victoria Street
 St. Lambert, Quebec J4S 1H1
 Monday-Friday 7:30 a.m to 6:00 EST
 Sat 9:00 a.m. to 4:00 p.m.

Westcoast Tool
 4008 Myrtle Street
 Burnaby, BC V5C 4G2
 Monday-Friday 8 a.m. to 4:30 p.m. PST

GENERAL INFORMATION

- * To place an order quickly, please have item numbers ready.
- * Listed prices valid in U.S. only.
- * Prices are subject to change without notice.

- * Please have your credit card number ready.
- * Please allow 2-4 weeks for delivery.
- * Canadian prices may be higher.
- * NO C.O.D.

PAYMENT METHOD									
<input type="checkbox"/> CHECK <input type="checkbox"/> MONEY ORDER <input type="checkbox"/> CREDIT CARD <input type="checkbox"/> OTHER	CARD NUMBER _____ EXPIRATION DATE _____ SIGNATURE _____								
Ship To _____ Address _____ City/State/Zip _____ Daytime Phone _____									
DREMEL 2009 ORDER FORM Prices Effective May-09	<table border="1" style="width: 100%; border-collapse: collapse;"> <tr> <td style="text-align: right;">Parts Sub Total</td> <td style="width: 50px;"></td> </tr> <tr> <td style="text-align: right;">(Your) State Sales Tax</td> <td></td> </tr> <tr> <td style="text-align: right;">Handling Charges</td> <td style="text-align: right;">\$4.00</td> </tr> <tr> <td style="text-align: right;">Total Remittance</td> <td style="text-align: right;">U.S.A. ONLY!!!!</td> </tr> </table>	Parts Sub Total		(Your) State Sales Tax		Handling Charges	\$4.00	Total Remittance	U.S.A. ONLY!!!!
Parts Sub Total									
(Your) State Sales Tax									
Handling Charges	\$4.00								
Total Remittance	U.S.A. ONLY!!!!								