

Installation and Operation Manual

Microprocessor-Controlled General Purpose Water Baths

Models

280 (2825/2826), **281** (2829/2830), **282** (2833/2834),
283 (2837/2838), **284** (2841/2842), **285** (2845/2846),
286 (2849/2850) and **288** (2853/2854)

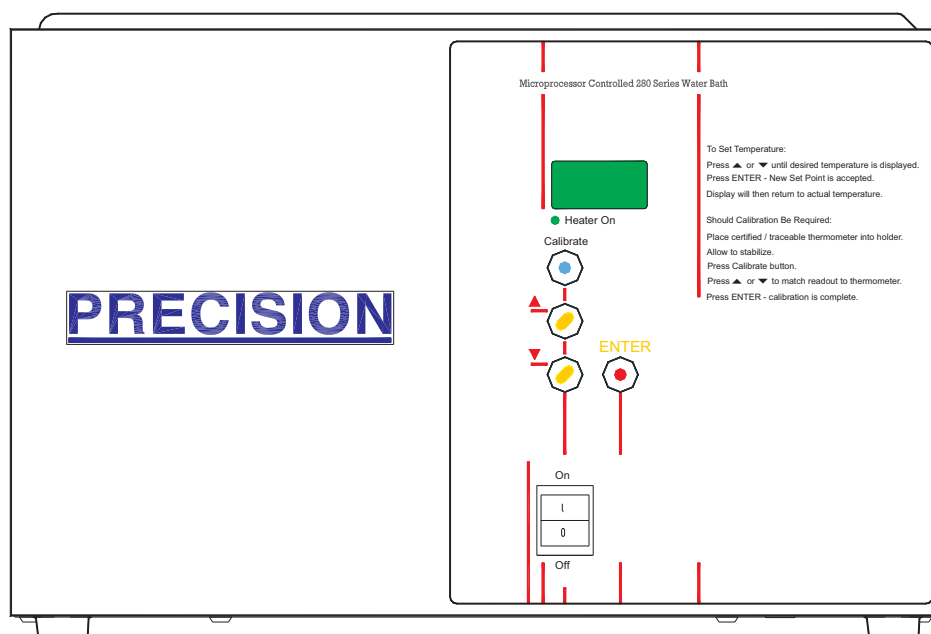

401 Millcreek Road, Box 649
Marietta, Ohio 45750
USA
Phone: 740-373-4763
Toll Free: 800-848-3080
FAX: 740-373-4189

Manual P/N3177877
Rev I Dated 29OCT09

Thermo
SCIENTIFIC

NOTE:

THE 240V UNITS DESCRIBED IN THIS MANUAL WERE DESIGNED SPECIFICALLY FOR THE EUROPEAN MARKET AND ARE SUPPLIED WITH A EUROPEAN STYLE POWER CORD. FOR DOMESTIC USE, A U.S. STYLE POWER CORD (P/N: 3176836) MUST BE ORDERED SEPARATELY.

NOTICE

THE MATERIAL IN THIS MANUAL IS FOR INFORMATION PURPOSES ONLY. THE CONTENTS AND THE PRODUCT IT DESCRIBES ARE SUBJECT TO CHANGE WITHOUT NOTICE. THERMO SCIENTIFIC MAKES NO REPRESENTATIONS OR WARRANTIES WITH RESPECT TO THIS MANUAL. IN NO EVENT SHALL THERMO BE LIABLE FOR ANY DAMAGES, DIRECT OR INCIDENTAL, ARISING OUT OF OR RELATED TO THE USE OF THIS MANUAL.

For repair information or replacement parts assistance from the manufacturer, call Technical Services using our toll free telephone number.

800-438-4851
(FAX) 740-373-4189

Table 3.1 Listing of Models Included in this Manual							
Model Number	Catalog Number	Electrical Characteristics			Capacity		240V Units Mains Fuse
		Volts	Watts	Amps	Liters	Gallons	
2825/ 2826	3166686 3166687	120 240	225	1.9 1	1.5	0.4	FST-5x20-1.0A
2829/ 2830	3166688 3166689	120 240	225	1.9 1	2.5	0.7	FST-5x20-1.0A
2833/ 2834	3166690 3166691	120 240	300	2.5 1.3	5.5	1.5	FST-5x20-2.0A
2837/ 2838	3166692 3166693	120 240	400	3.3 1.7	12.0	3.2	FST-5x20-2.0A
2841/ 2842	3166694 3166695	120 240	600	5 2.6	19.5	5.2	FST-5x20-3.15A
2845/ 2846	3166696 3166697	120 240	600	5 2.6	18.0	4.9	FST-5x20-3.15A
2849/ 2850	3166698 3166699	120 240	1200	10 5.2	43.0	11.4	FST-5x20-6.3A
2853/ 2854	3166700 3166701	120 240	800	6.7 3.5	12.0*	3.2*	FST-5x20-3.15A
* Each chamber							
For all 240V models: Power Supply Board Fuse - FST-5x20-6.3mA							

REVISION STATUS

INDEX	DATE	AMENDED PAGES	NOTES
A	12/98		Initial release
B	02/00	17	Pictorial update of wiring per ECO JGC000223A
C	07/01	2,8,9,12,17	updated electrical specifications
D	NOV01	5	Add caution "acidic & caustic substance"
E	4/05	36100112 (340016400)	new manual #, manufacture location
F	5/06	ECR 23443 & 23496	consolidated with the 240V manual 3177693, updated specs
G	1/08	ECR 24361	Added warning not to operate without water in the bath.
H	9/08	ECR 24808	Revised water specifications
I	10/09	ECR25795/BA-684	temp performance with gable only

Contents

1. Introduction	1
2. Unpacking and Damage	1
3. General Information	2
4. Performance Data	3
5. Installation	3
6. Explanation of Controls	4
7. Operation	5
8. Maintenance	6
9. Troubleshooting	7
10. Parts Replacement	10
11. Replacement Parts List	12
12. Assembly and Schematic Drawings	14
13. Warranty	19

1.0 INTRODUCTION

- 1.01** Your satisfaction and safety are important to Thermo and a complete understanding of this unit is necessary to attain these objectives.
- 1.02** As the ultimate user of this apparatus, you have the responsibility to understand its proper function and operational characteristics. This instruction manual should be thoroughly read and all operators given adequate training before attempting to place this unit in service. Awareness of the stated cautions and warnings, and compliance with recommended operating parameters — together with maintenance requirements—are important for safe and satisfactory operation. The unit should be used for its intended application; **alterations or modifications will void the warranty.**

WARNING

AS A ROUTINE LABORATORY PRECAUTION, ALWAYS WEAR SAFETY GLASSES WHEN WORKING WITH THIS APPARATUS.

- 1.03** This product is not intended, nor can it be used, as a sterile or patient connected device. In addition, this apparatus is not designed for use in Class I, II, or III locations as defined by the National Electrical Code.

2.0 UNPACKING AND DAMAGE

- 2.01** This product was carefully packed and thoroughly inspected before leaving our factory. Save all packing material if apparatus is received damaged.
- 2.02** Responsibility for safe delivery was assumed by the carrier upon acceptance of the shipment; therefore, claims for loss or damage sustained in transit must be made upon the carrier by the recipient as follows:

Visible Loss or Damage: Note any external evidence of loss or damage on the freight bill or express receipt, and have it signed by the carrier's agent. Failure to adequately describe such external evidence of loss or damage may result in the carrier's refusing to honor your claim. The form required to file such claim will be supplied by the carrier.

Concealed Loss or Damage: Concealed loss or damage is any loss or damage which does not become apparent until the merchandise has been unpacked and inspected. Should either occur, make a written request for inspection by carrier's agent within 15 days of the delivery date; then file a claim with the carrier.

- 2.03** If you follow the above instructions carefully, Thermo will guarantee our full support of your claim to be compensated for loss or damage in transit.

DO NOT — for any reason — return this unit to Thermo without first obtaining return authorization. In any correspondence with Thermo, please supply the nameplate data, including catalog number and serial number.

3.0 GENERAL INFORMATION

3.01 Precision Baths are widely used in research and quality control. Their superb temperature uniformity and stability makes them especially desirable for legal or reference tests.

CAUTION

DO NOT APPLY POWER TO THE WATER BATH BEFORE FILLING THE WATER BATH PAN WITH THE RECOMENDED WATER SOLUTION (SEE SECTION 7.02). OPERATING THE BATH WITHOUT A WATER SOLUTION COULD RESULT IN OVERHEATING AND DAMAGE TOT HE HEATER.

3.02 The microprocessor control panel houses all functions necessary to operate the bath. The push-button keys and single display window allows the operator to adjust bath temperature and temperature calibration via a single set of controls.

3.03 The Proportional Integral Derivative (PID) temperature control allows precise temperature control. Use of the gable cover provided is required to maintain optimal temperature sensitivity.

3.04 A high limit temperature cutout is provided in the event of an empty water bath. If the sensor reads a temperature 5°C higher than the set temperature, a high temperature cutout will occur indicated by a display reading of "EEE," and the heater will be inhibited from operating. To reset the bath, the power must be turned off and then back on again. The high limit temperature cutout is internally set for 5°C above any set temperature and can not be set by the user.

3.05 The interior of the bath is constructed of stainless steel and is designed for operation with **distilled water** or water solutions, such as water ethylene glycol with corrosion inhibitor's added. The body is made from galvanized steel and is painted for added protection. A gable cover is also provided with the bath.

3.06 The 240-volt units are identical in appearance to the 120-volt units.

NOTE:

USING CHLORINATED TAP WATER OR ADDITIVES THAT CONTAIN CHLORINE WILL VOID THE MANUFACTURER'S WARRANTY. SIMILARLY, HIGH PURITY (DEIONIZED) WATER THAT DOES NOT FALL WITHIN THE RESISTIVITY RANGE OF 50K TO 1M OHM AND THE PH RANGE FROM 7 TO 9 WILL VOID THE WARRANTY. CONTACT TECHNICAL SERVICES WITH ANY QUESTIONS.

4.0 PERFORMANCE DATA

4.01 The following performance specifications for bath models 280 through 288 are **valid only when the gable cover is in place.**

Control sensitivity @ 37C = $\pm 0.1C$
Temperature uniformity @ 37C = $\pm 0.2C$
Minimum bath temperature = Ambient +5C
Maximum bath temperature

5.0 INSTALLATION

WARNING

INSTALLATION SHOULD BE COMPLETED BY QUALIFIED PERSONNEL ONLY.

5.01 1. The most uniform operating conditions and results will be obtained by placing the bath on a level surface in an area remote from drafts, ventilating outlets, radiators, and other rapidly changing ambient conditions.

2. Place the stainless steel metal shelf (corners facing downward) inside the bath chamber. The shelf (Diffuser Pan) provides a sample base and protects samples from touching the hot metal bath bottom. If it is necessary to increase the height of the diffuser pan, a Leg Extension Kit is included for this purpose, except for the Model 2829/2830. Following the figure shown below, attach the 4 extension legs to each of the four corners of the diffuser pan.

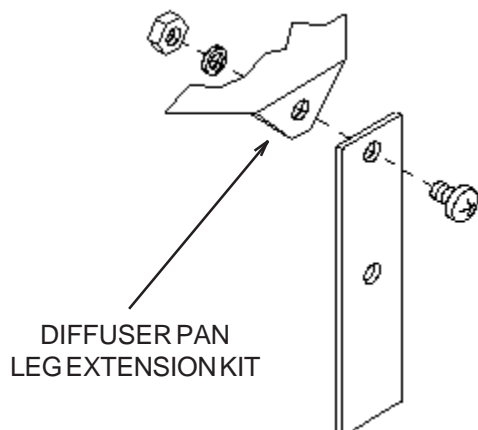

5.02 Electrical Connections -

WARNING

FOR PERSONAL SAFETY, THIS APPARATUS MUST BE PROPERLY GROUNDED.

1. The power cord provided on this unit is equipped with a three-prong (grounding) plug which mates with standard three-prong grounding wall receptacle to minimize the possibility of electric shock hazard from this apparatus. If in doubt the user should have the wall receptacle and circuit checked by a qualified electrician to make sure the receptacle can provide adequate current and is properly grounded.
2. Where a standard two-prong wall receptacle is encountered, it is the personal responsibility and obligation of the user to have it replaced with a properly grounded three-prong wall receptacle. **Do not, under any circumstances, cut or remove the third (ground) prong from the power cord. Do not use a two-prong adapter plug.**

5.03 Determine the total amount of current being used by other apparatus connected to the circuit that will be used for this apparatus. It is critical that the added current demand (see nameplate) of this and other equipment used on the same circuit does not exceed the rating of the fuse or circuit breaker.

Environmental Conditions-

This instrument is designed to operate safely under the following conditions:

- Indoor Use Only
- Temperature: 5° to 40° C
- Maximum Relative Humidity: 80% for temperatures to 22° C
- Maximum Altitude 2000 meters

Maximum performance is assured across the following temperature range:

- 15°C to 45°C

CAUTION

- **BE SURE THAT THE POWER SUPPLY IS OF THE SAME VOLTAGE AS SPECIFIED ON NAMEPLATE.**
- **BE SURE THAT THE WALL RECEPTACLE IS READILY IDENTIFIABLE AND EASILY REACHED TO DISCONNECT UNIT FROM POWER SOURCE.**

6.0 EXPLANATION OF CONTROLS

6.01 Power Switch - The power switch is located near the lower portion of the control panel and provides power to the entire unit.

6.02 Control Panel - The Control Panel provides a digital readout of temperature readings, heater on indicator, and keys for user to make their desired selections.

1. **LED Display** - Three digits are used to display the actual, set, and calibrated values for temperature.

2. **Heater On Lamp** - The "HEATER ON" lamp is lit when power is applied to the heater.

3. **Calibrate Key** - This key puts the unit in calibrate mode to match a traceable thermometer to the actual temperature display.

4. **Temperature Selection Keys** - These keys are used to increase or decrease the setpoint and/or calibrate temperature selections.

5. **Enter Key** - The enter key is used to store a new setpoint or calibration value.

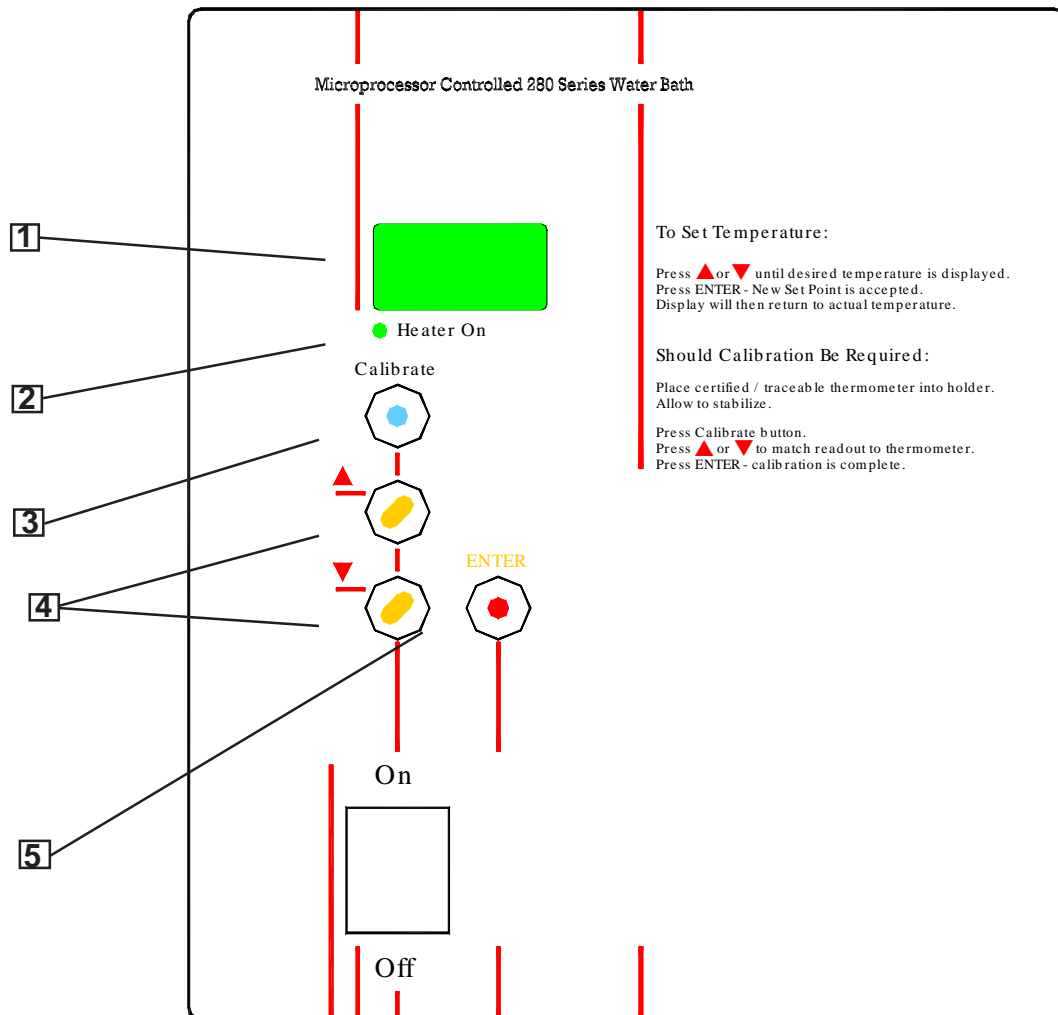

7.0 OPERATION

CAUTION:

EXERCISE CARE WHEN USING ACIDIC OR CAUSTIC SOLUTIONS AS THEY WILL ATTACK THE GALVANIZED STEEL BATH BODY IF SPILLED INTO THE BATH. IF SPILLS DO OCCUR, THE BATH LIQUID SHOULD BE IMMEDIATELY DRAINED AND THE UNIT THOROUGHLY FLUSHED. SPILLS AND CONDENSATION SHOULD BE CLEANED/REMOVED FROM ALL METAL SURFACES AFTER EACH USE.

7.01 When filling the bath with water, allowance must be made for the displacement of water upon immersion of samples. The maximum liquid level is 1 inch below the top of the pan.

7.02 To conserve energy, reduce evaporation, increase temperature control accuracy, and reach/maintain 100°C, use the gable cover provided. Do not use aluminum foil as a cover, as it may cause corrosion due to an electrochemical reaction.

1. Add distilled water to bath. The water level should be no closer than 1" from the top of the bath when the bath is fully loaded. **NOTE: Use sterile distilled water only.** The acceptable resistivity range is 50K to 1M ohms (conductivity 1 to 20 micro Siemens). The acceptable pH range is 7 to 9.
2. Power up: Depress the power switch located at the lower end of the control panel. Immediately after turning on power, all of the segments of the display will be on along with the HEATER ON indicator. After 3 seconds, the current set temperature will be displayed and this will last for 5 seconds. Then the display will change to the actual bath temperature.
3. To display the set temperature, quickly press the \wedge (up) or \vee (down) key. The current set temperature will be displayed. After 5 seconds, the display will return to the actual bath temperature.

4. To change the set temperature, continuously press the \wedge or \vee key until the desired set temperature is displayed. When continuously pressing either the \wedge or \vee keys, the display changes slowly at first but after 1 degree has passed, the display begins to change rapidly. After the desired set temperature is achieved, then press the ENTER key. The display with the new set temperature will flash three times and then it will return to the bath temperature.

If the ENTER key is NOT pressed, the expected new set temperature will not be accepted and the water bath will control at the previous set temperature.

5. The water baths are calibrated at the factory for use over a wide range of temperatures. Due to non-linearities in the control system, it may be necessary to make the display match a calibrated thermometer's reading, even though the difference might be only a few tenths of a degree.

The calibrate function should be used only to match a STABLE bath's actual temperature to the calibrated thermometer.

To perform calibration, press the CALIBRATE key. The display changes to CAL, then flashes back to bath temperature. This occurs four times, if no other keys are pressed, then it resumes displaying the bath temperature.

After inserting a calibrated thermometer into the holder and letting it stabilize for a minimum of 15 minutes, note its reading.

Press the CALIBRATE key once again and while the display is flashing, press either the \wedge or \vee key to make the display match the noted thermometer reading. After the desired display is achieved, press the ENTER key. The display flashes three times with the adjusted reading, then stops flashing. The bath is now calibrated more accurately for the control set point.

WARNING

EXPLOSION, IMPLOSION OR THE RELEASE OF TOXIC OR FLAMMABLE GASES ARISING FROM THE MATERIAL BEING HEATED IS THE SOLE RESPONSIBILITY OF THE USER.

8.0 MAINTENANCE

8.01 Cleaning and care of stainless steel: Stainless steel will resist corrosion; however, it is not impervious to it. For maximum life, stainless steel must receive a certain amount of care.

CAUTION

AVOID SPILLING HARSH CHEMICALS ONTO THE BATH, AS CORROSION OF THE STAINLESS STEEL MAY RESULT.

1. There are many chemical cleaners, but usually just changing the water and periodic cleaning with mild soapy water or a non-scratching scouring power will suffice.

Should algae or other undesirable microorganisms form on the top of the bath media, add a little formaldehyde or zephiran chloride to alleviate this problem.

CAUTION

ELECTROLYSIS CAN DAMAGE STAINLESS STEEL. THIS CAN OCCUR IF AN OBJECT IS ALLOWED TO REST DIRECTLY ON THE SURFACE, TRAPPING MOISTURE THAT BECOMES OXYGEN STARVED BUT IS SURROUNDED BY WATER CONTAINING OXYGEN. THE RESULTING ELECTROLYTIC ACTION WILL PIT OR ERODE THE STAINLESS STEEL.

2. Should it be necessary to use a media other than water such as those listed below, limit the time to a maximum of four hours. Clean surfaces immediately after use.

Aluminum Chloride	Barium Chloride
Bichloride of Mercury	Calcium Chloride
Carbolic Acid	Chlorinated Lime
Citric Acid (boiling)	Dakin's Solution
Ferrous Chloride	Mercury Salts
LysolMercuric Chloride	Phenol
Potassium Permanganate	Stannous Chloride
Sodium Hypochlorite	Tartaric Acid
Potassium Thiocyanate	

CAUTION

*NEVER USE THE FOLLOWING CHEMICALS:
AQUA REGIA FERRIC CHLORIDE IODINE
SODIUM AZIDE SULFURIC ACID*

3. Should the stainless steel ever become discolored by iron rust, use the following procedure to remove all traces of the rust and restore the stainless steel.

WARNING

ALWAYS OBSERVE THE FOLLOWING SAFETY PRECAUTIONS! USE HEAVY GLOVES OR OTHER ADEQUATE HAND PROTECTION. WEAR GOGGLES OR OTHER ADEQUATE EYE PROTECTION. WORK ONLY IN AREAS WITH ADEQUATE VENTILATION.

Prepare a solution of 20% nitric and 1.5% hydrochloric acid (if preferred, a 2% to 5% solution of warm oxalic acid may be used). Swab solution over surface, allowing it to remain until all rust is loosened. This will usually take 1 to 2 minutes.

As soon as rust is loosened, immediately flush with clean water until all acid is removed. Dry thoroughly.

4. During operation, quite a bit of condensation forms on the inside of the gable cover. When removing the gable cover, have one of its corners centered above the water bath, so that the water runoff goes into the bath. Shaking the cover aids the water runoff. Be sure to wipe up any water spillage on or around the bath.

IMPORTANT

THE USER HAS THE RESPONSIBILITY FOR CARRYING OUT THE APPROPRIATE DECONTAMINATION IF HAZARDOUS MATERIAL IS SPILLED ON OR INSIDE THE BATH.

9.0 TROUBLESHOOTING

WARNING

SERVICE SHOULD BE PERFORMED BY A QUALIFIED TECHNICIAN. BEFORE REPLACING ANY ELECTRICAL OR MECHANICAL COMPONENTS, UNPLUG THE LINE CORD. IF ELECTRICAL POWER IS REQUIRED FOR SERVICE, USE EXTREME CARE.

9.01 Refer to Troubleshooting Procedures Table (9.03 through 9.06) for troubleshooting information on the baths. This table provides the basic information required to repair the bath.

9.02 The following is a list of the tools and instruments required to perform the procedures outlined in the Troubleshooting Procedures table.

Suggested Tools:

- Phillips Screwdriver
- 7/16" Socket or adjustable wrench
- Ohmmeter
- DC Voltmeter
- AC Voltmeter
- 5VDC Power Supply
- Nut Driver 11/32"

Troubleshooting Procedures																														
Problem		Procedure																												
9.03 No Heat	1. Verify that setpoint temperature is greater than the actual water temperature.																													
	2. Check temperature probe. <ul style="list-style-type: none"> A. Disconnect unit from electrical supply. B. Disconnect temperature probe connector J5 from Control Board. C. Place 5 volt DC between Pins 1 & 3 on temperature probe connector. D. Place a voltmeter between Pins 2 & 3 on temperature probe connector. Place the temperature probe in a bath of known temperature. Verify that the output voltage of the temperature probe approximately corresponds to the values in the table below. <p style="text-align: center;">Degrees Centigrade vs. Output Voltage of Temperature Probe</p> <table style="width: 100%; border-collapse: collapse;"> <thead> <tr> <th style="text-align: left;">Temp °C</th> <th style="text-align: left;">Vout</th> <th style="text-align: left;">Temp °C</th> <th style="text-align: left;">Vout</th> </tr> </thead> <tbody> <tr> <td>0</td> <td>320mV</td> <td>60</td> <td>1.400V</td> </tr> <tr> <td>10</td> <td>500mV</td> <td>70</td> <td>1.580V</td> </tr> <tr> <td>20</td> <td>680mV</td> <td>80</td> <td>1.760V</td> </tr> <tr> <td>30</td> <td>860mV</td> <td>90</td> <td>1.940V</td> </tr> <tr> <td>40</td> <td>1.040V</td> <td>99.9</td> <td>2.218V</td> </tr> <tr> <td>50</td> <td>1.220V</td> <td></td> <td></td> </tr> </tbody> </table>			Temp °C	Vout	Temp °C	Vout	0	320mV	60	1.400V	10	500mV	70	1.580V	20	680mV	80	1.760V	30	860mV	90	1.940V	40	1.040V	99.9	2.218V	50	1.220V	
Temp °C	Vout	Temp °C	Vout																											
0	320mV	60	1.400V																											
10	500mV	70	1.580V																											
20	680mV	80	1.760V																											
30	860mV	90	1.940V																											
40	1.040V	99.9	2.218V																											
50	1.220V																													

Troubleshooting Procedures

Problem	Procedure																																														
9.03 No Heat (cont.)	<p>E. If a 5V DC power supply is not available, leave J5 connected to the control board, turn power on, and repeat step D by placing the voltmeter probes on J5, Pins 2 & 3.</p>																																														
	<p>4. Check Heater.</p> <p>A. Disconnect unit from electrical supply.</p> <p>B. Obtain access to the heater by removing the bottom cover and then removing the insulation. The heaters have red and white wires connected to them from the control board. Disconnect the red wire from the heater to isolate it from the board. Connect an ohm meter across the heater. Then using the chart below, determine which reading you should obtain depending on the model. On most of the 240-volt models, there are two separate heaters which are connected in series. The values below are approximate. If the resistance varies more than $\pm 20\%$ from these listed values, then the heater should be replaced.</p> <table style="margin-left: 40px; border: none;"> <tbody> <tr> <td style="padding-right: 20px;">280-120V</td> <td>60 Ohms</td> </tr> <tr> <td>280-240V</td> <td>260 Ohms</td> </tr> <tr> <td colspan="2"> </td> </tr> <tr> <td style="padding-right: 20px;">281-120V</td> <td>60 Ohms</td> </tr> <tr> <td>281-240V</td> <td>260 Ohms</td> </tr> <tr> <td colspan="2"> </td> </tr> <tr> <td style="padding-right: 20px;">282-120V</td> <td>48 Ohms</td> </tr> <tr> <td>282-240V</td> <td>196 Ohms Total (98 Ohms each)</td> </tr> <tr> <td colspan="2"> </td> </tr> <tr> <td style="padding-right: 20px;">283-120V</td> <td>35 Ohms</td> </tr> <tr> <td>283-240V</td> <td>140 Ohms Total (70 Ohms each)</td> </tr> <tr> <td colspan="2"> </td> </tr> <tr> <td style="padding-right: 20px;">284-120V</td> <td>25 Ohms</td> </tr> <tr> <td>284-240V</td> <td>100 Ohms Total (50 Ohms each)</td> </tr> <tr> <td colspan="2"> </td> </tr> <tr> <td style="padding-right: 20px;">285-120V</td> <td>25 Ohms</td> </tr> <tr> <td>285-240V</td> <td>100 Ohms Total (50 Ohms each)</td> </tr> <tr> <td colspan="2"> </td> </tr> <tr> <td style="padding-right: 20px;">286-120V</td> <td>25 Ohms</td> </tr> <tr> <td>286-240V</td> <td>100 Ohms Total (50 Ohms each)</td> </tr> <tr> <td colspan="2"> </td> </tr> <tr> <td style="padding-right: 20px;">288-120V</td> <td>35 Ohms</td> </tr> <tr> <td>288-240V</td> <td>140 Ohms Total (70 Ohms each)</td> </tr> </tbody> </table> <p style="margin-left: 40px;">Re-connect the red wire back to the heater.</p>	280-120V	60 Ohms	280-240V	260 Ohms			281-120V	60 Ohms	281-240V	260 Ohms			282-120V	48 Ohms	282-240V	196 Ohms Total (98 Ohms each)			283-120V	35 Ohms	283-240V	140 Ohms Total (70 Ohms each)			284-120V	25 Ohms	284-240V	100 Ohms Total (50 Ohms each)			285-120V	25 Ohms	285-240V	100 Ohms Total (50 Ohms each)			286-120V	25 Ohms	286-240V	100 Ohms Total (50 Ohms each)			288-120V	35 Ohms	288-240V	140 Ohms Total (70 Ohms each)
280-120V	60 Ohms																																														
280-240V	260 Ohms																																														
281-120V	60 Ohms																																														
281-240V	260 Ohms																																														
282-120V	48 Ohms																																														
282-240V	196 Ohms Total (98 Ohms each)																																														
283-120V	35 Ohms																																														
283-240V	140 Ohms Total (70 Ohms each)																																														
284-120V	25 Ohms																																														
284-240V	100 Ohms Total (50 Ohms each)																																														
285-120V	25 Ohms																																														
285-240V	100 Ohms Total (50 Ohms each)																																														
286-120V	25 Ohms																																														
286-240V	100 Ohms Total (50 Ohms each)																																														
288-120V	35 Ohms																																														
288-240V	140 Ohms Total (70 Ohms each)																																														

Troubleshooting Procedures	
Problem	Procedure
	5. Check TRIAC (High voltage output of control board) A. Make sure power is disconnected from the unit. B. Connect an AC voltmeter across the heater capable of reading 120 or 240 volts, depending on your particular unit. C. Turn power on and select a set point higher than the actual temperature to get the HEATER ON indicator to illuminate. With the HEATER ON indicator lit, there should be either 120 or 240 volts across the heater. If not, the control board should be replaced.
9.04 Unstable temperature control	1. Use gable cover provided to improve temperature control.
	2. Verify that temperature setpoint is set at desired value.
	3. If control is stable, but not at desired temperature, check set temperature or perform calibration (Paragraph 7.0, Step 5).
	4. Check Temperature Probe (see Paragraph 9.03, Step 2).
9.05 Too much heat	1. Check Temperature Probe (see Paragraph 9.03, Step 2).
	2. Check TRIAC (see Paragraph 9.03, Step 5).
9.06 No Display	1. Verify that the water bath is plugged in.
	2. Verify that Power switch is in the on position.
	3. Disconnect unit from the electrical supply, gain access to the control board and check Fuse 1 located near the transformer on the control board.

10.0 PARTS REPLACEMENT

WARNING

BEFORE REPLACING ANY PART, BE SURE BATH IS DISCONNECTED FROM POWER SOURCE. SERVICE SHOULD BE PERFORMED BY A QUALIFIED TECHNICIAN.

10.01 Before removing any parts for replacement, verify part in question by following the instructions listed in the troubleshooting guide.

10.02 Refer to Parts Replacement Table below for appropriate replacement procedures. Failure to follow parts replacement procedures may cause damage to the bath.

Parts Replacement	
10.03 Replace Temperature Sensor	1. Remove the necessary screws to remove the bottom pan from underneath the water bath. Then remove the insulation necessary to view the temperature sensor and its orientation when connected to the control board.
	2. Disconnect the sensor from the control board at J5.
	3. The temperature sensor is mounted to the pan with a steel clamp. Loosen the nut that holds the clamp which in turn holds the sensor in place. Note that the sensor has its flat side against the pan. When installing a new sensor, it is important to do the same.
	4. Reverse the procedure to install the new sensor.
	5. Recalibrate the water bath with the new sensor. See Section 7.0 Operation, Step 5.
10.04 Replace Heater	1. Remove the necessary screws to remove the bottom pan from underneath the water bath. Then remove the insulation necessary to gain access to the heater(s).
	2. Disconnect the wires that are attached to the heaters.
	3. Using a 11/32" nut driver, remove the nuts that hold the heater brackets in place.
	4. Replace the heater(s), heater brackets, and re-attach the wires.
10.05 *Replace Control Board	1. Remove the necessary screws to remove the bottom pan from underneath the water bath. Then remove the insulation necessary to gain access to the control board, and hex nuts which hold the bath pan to the body.

Parts Replacement (cont.)

10.05 Replace Control Board (cont.)	2. Disconnect the wires that are attached to the heater. Then disconnect the temperature sensor from J5 on the control board.
	3. Remove the bath pan from the body by removing each 11/32" nut from each corner of the pan. NOTE: Model 2849/2850 has 6 hex nuts which hold the pan in place.
	4. Disconnect J1 and J2 from the control board.
	5. Remove the 4 nuts that support the board. Remove the control board and replace it, then reverse this procedure.
10.06 Replace Diffuser Pan Leg Extension	1. Attach the four extension legs to each of the four corners of the diffuser pan using the nut, splitwasher and screw provided. Refer to figure shown on page 3 of this manual.

***CAUTION**

When replacing the Control Board #3176801, note the following:

1. For 120 Volt models, JP3 and JP4 must be installed.
2. For 240 Volt models, JP3 and JP4 must be removed.

11.0 Replacement Parts List

	120-Volt Models							
	2825	2829	2833	2837	2841	2845	2849	2853
Pan	3177554	3177576	3177572	3177573	3177577	3177574	3177578	3177573
Diffuser Plate Asm.	3163798	3163797	3163798	3163801	3163799	3163805	3163804	3163801
PCB Asm.	3176801							
Heater	3175493	3175493	3175494	3175495	3175496	3175496	3175496	3175495
Heater Harness	3176805							
Power Harness	3176807							
Temp. Probe Assembly	3177640							
Heater Insulator	3177733	3177733	3177734	3177735	3177736	3177736	3177736	3177735
On/Off Switch	3175318							
Leg Extension Kit	3161440							
Line Cord	3178034							
Gable Cover	3166202	3161572	3166202	3166203	3166206	3166217	3166218	3166203

	240-Volt Models							
	2826	2830	2834	2838	2842	2846	2850	2854
Pan	3177554	3177576	3177572	3177573	3177577	3177574	3177578	3177573
Diffuser Plate Assy.	3163798	3163797	3163798	3163801	3163799	3163805	3163804	3163801
PCB Assy.	3176801							
Heater	3175487	3175487	3175476	3175477	3175478	3175478	3175478	3175477
Heater Harness	3176806							
Power Harness	3176808							
Temp. Probe Assy.	3177640							
Heater Insulator	3177733	3177733	3177734	3177735	3177736	3177736	3177736	3177735
On/Off Switch	3175318							
Leg Extension Kit	3161440							
Line Cord	3176551							
Mains Fuse	3172453	3172453	3172461	3172461	3172442	3172442	3172449	3172442
Controller PCB Fuse	3175929							
Gable Cover	3166202	3161572	3166202	3166203	3166206	3166217	3166218	3166203

12.0 ASSEMBLY & SCHEMATIC DRAWINGS

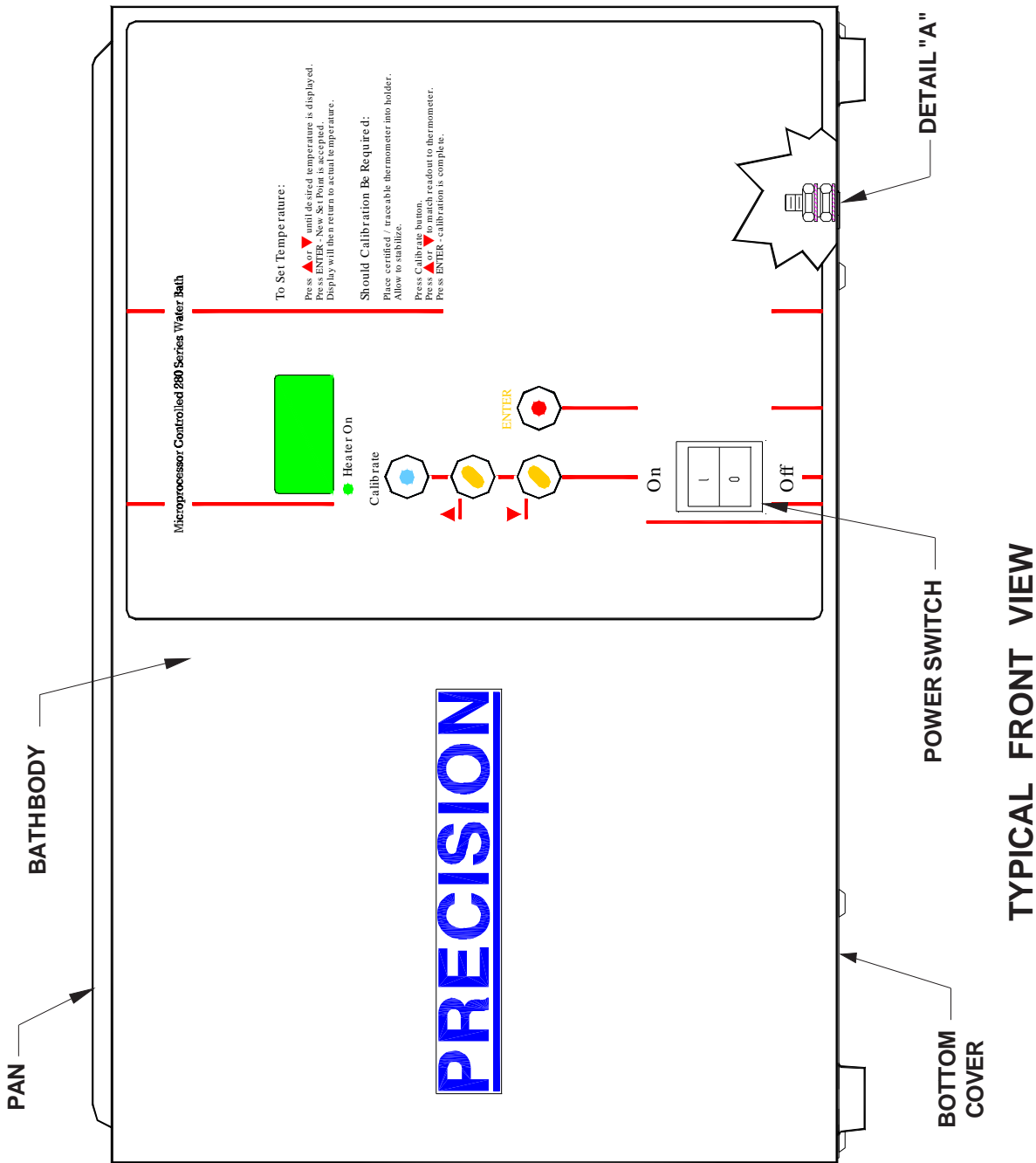

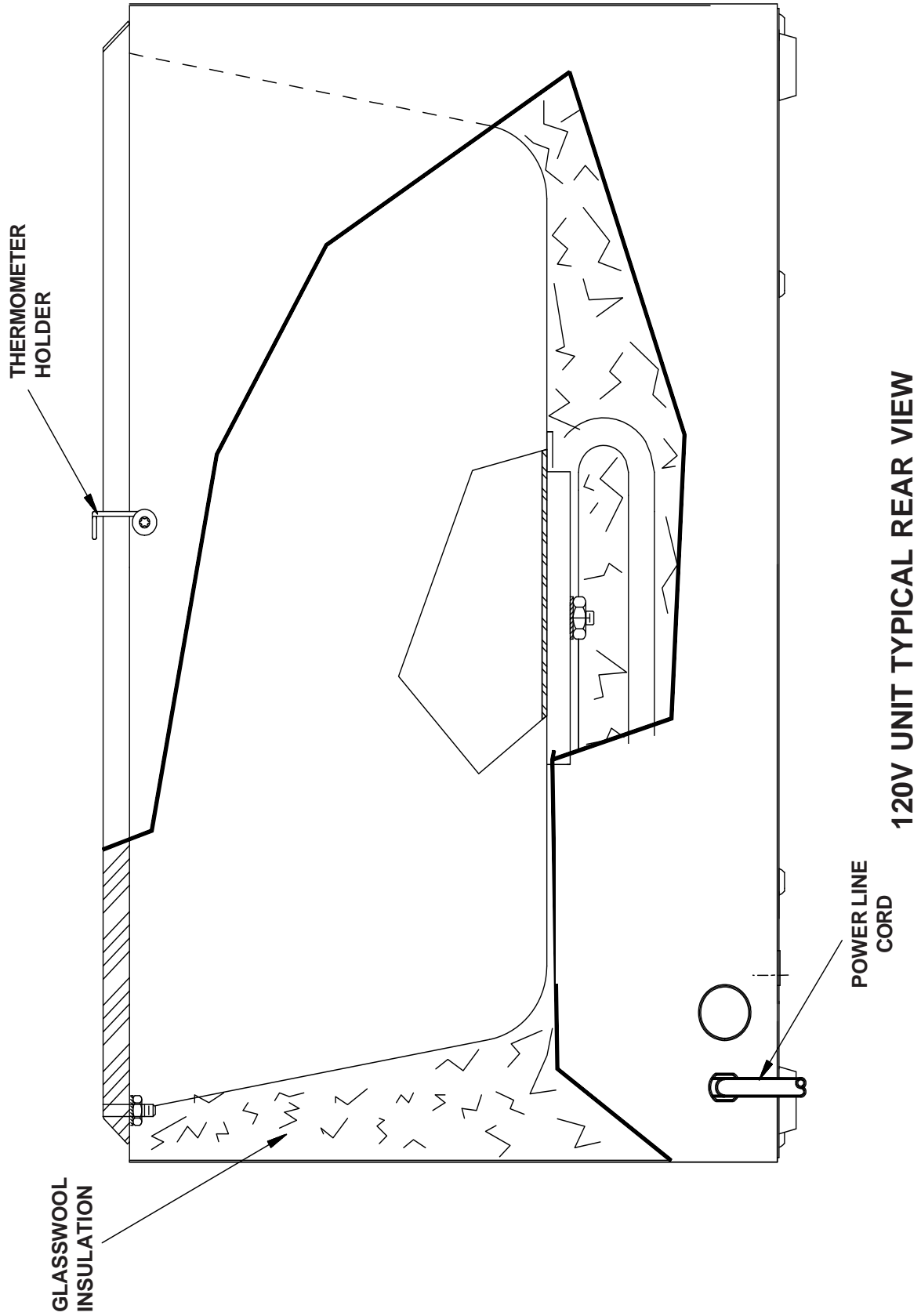

120V UNIT TYPICAL REAR VIEW

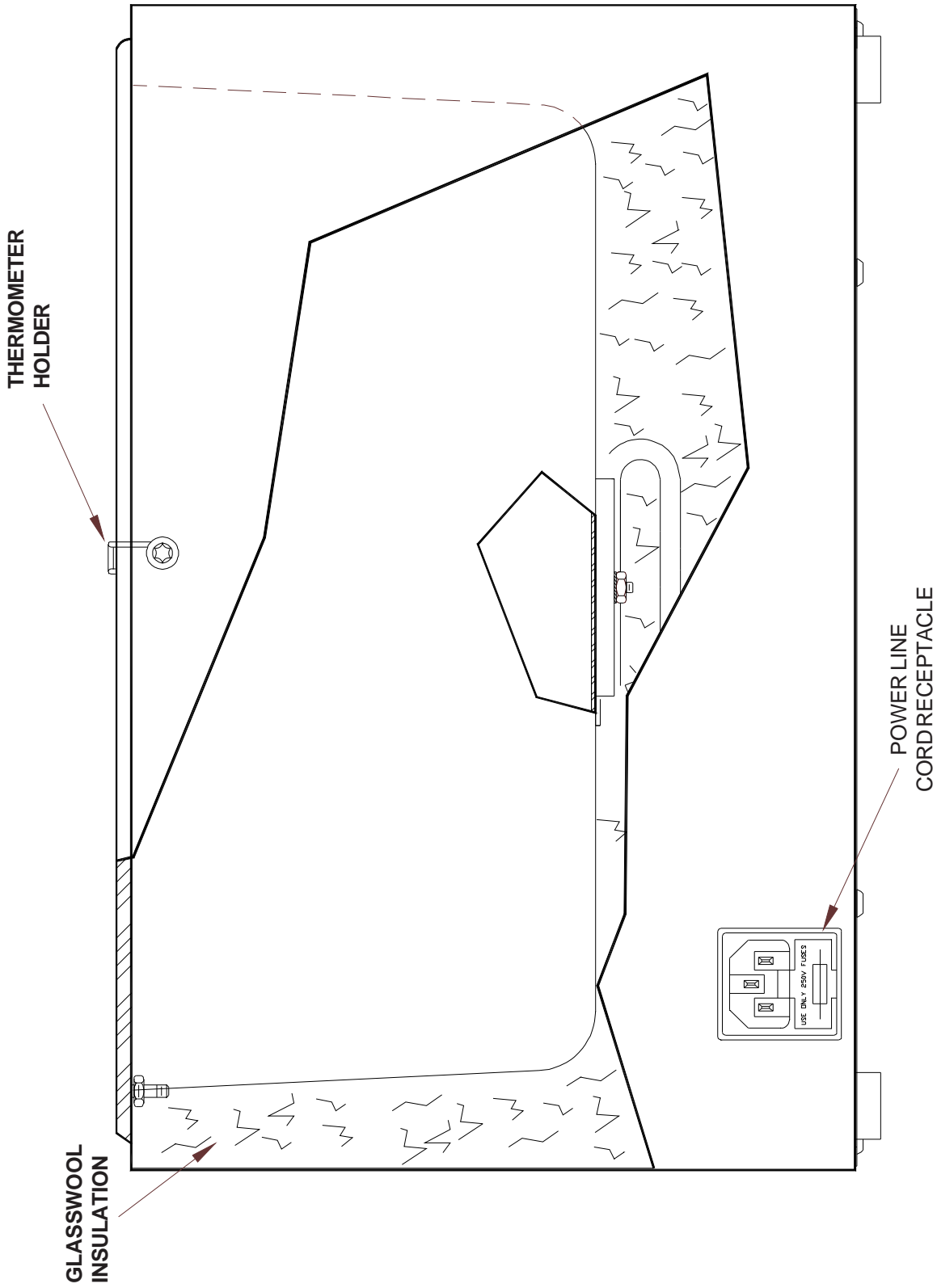

THERMOMETER
HOLDER

GLASSWOOL
INSULATION

POWER LINE
CORD RECEPTACLE

240V UNIT TYPICAL REAR VIEW

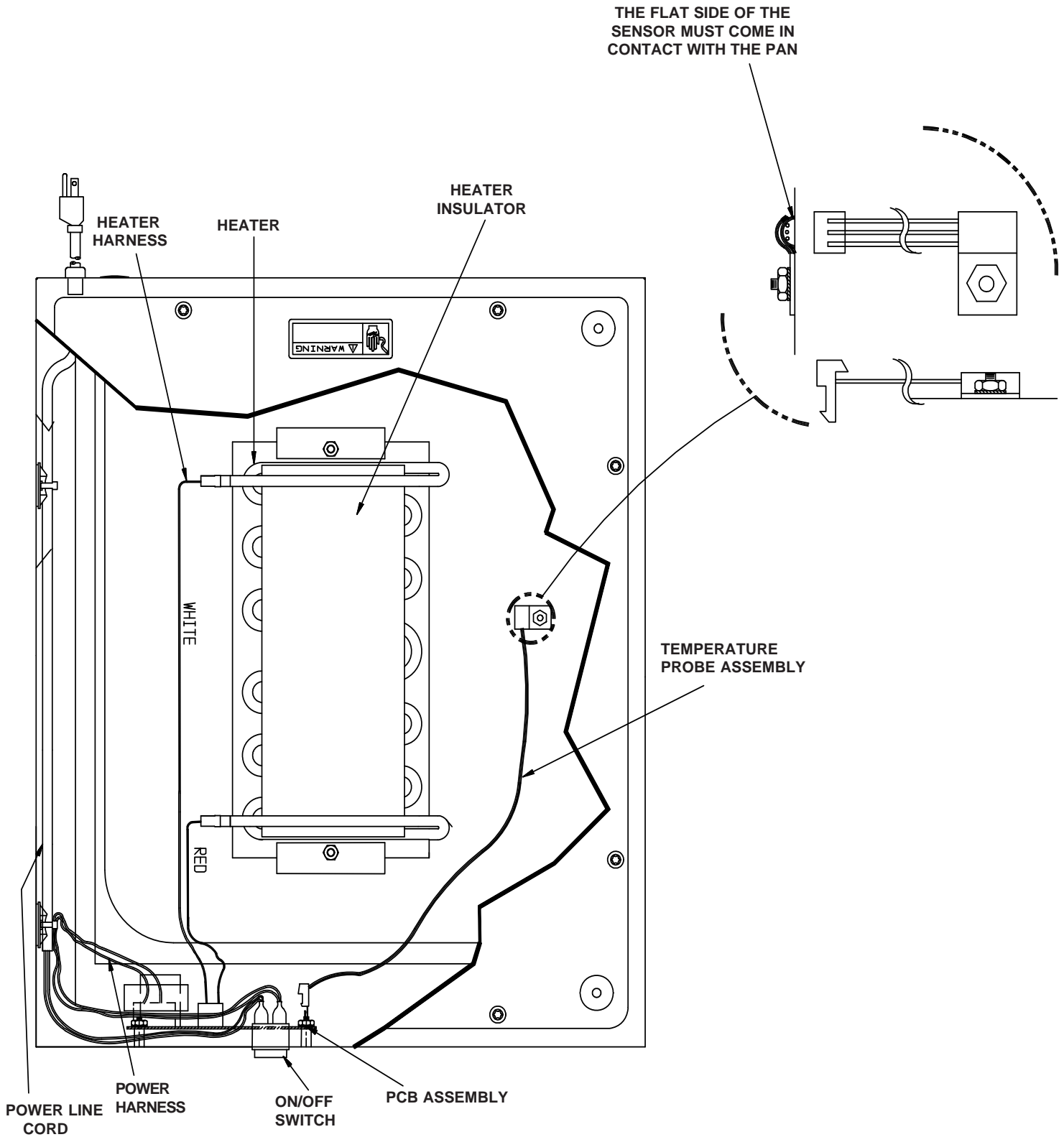

120V UNIT TYPICAL BOTTOM VIEW

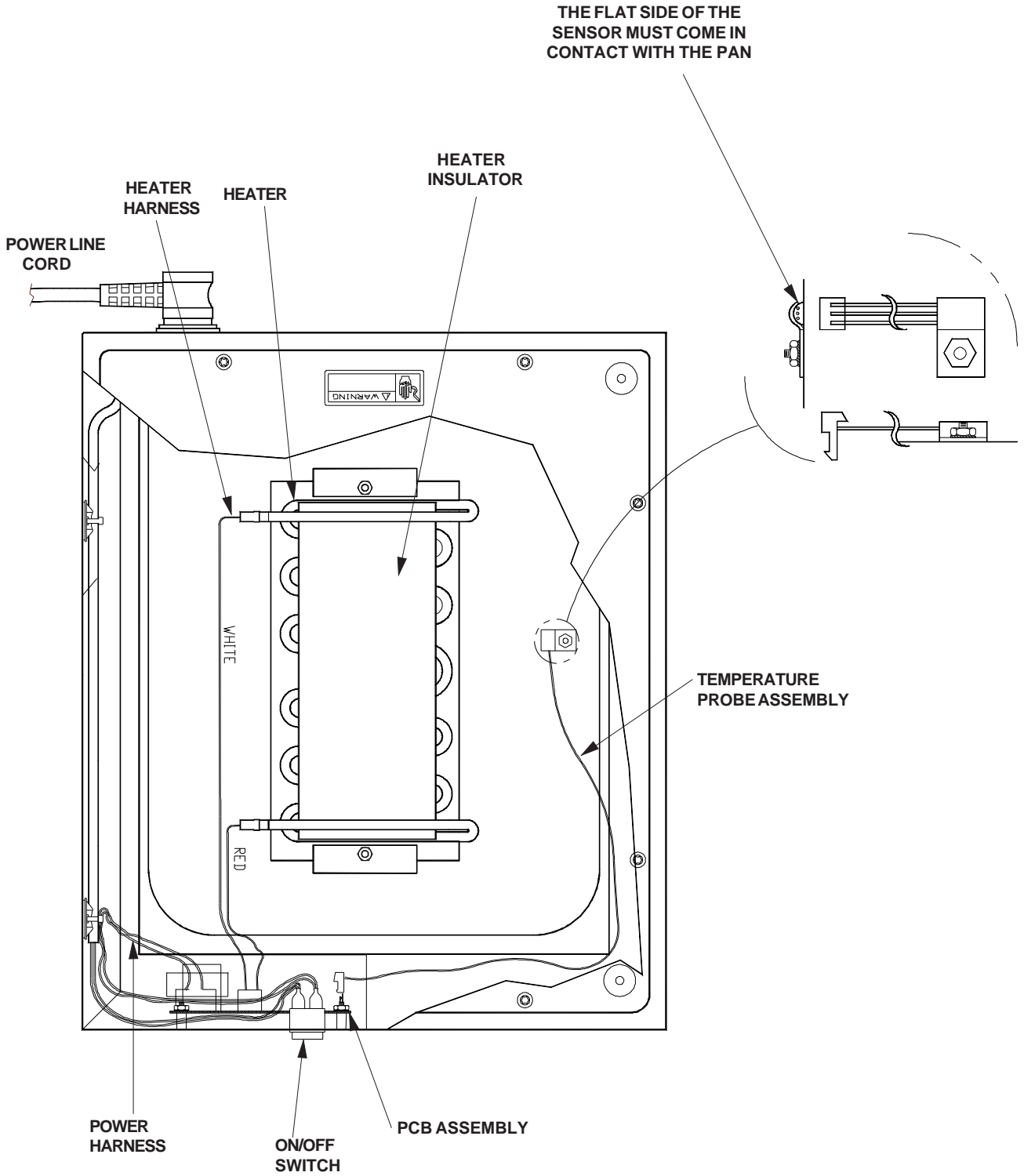

240V UNIT TYPICAL BOTTOM VIEW

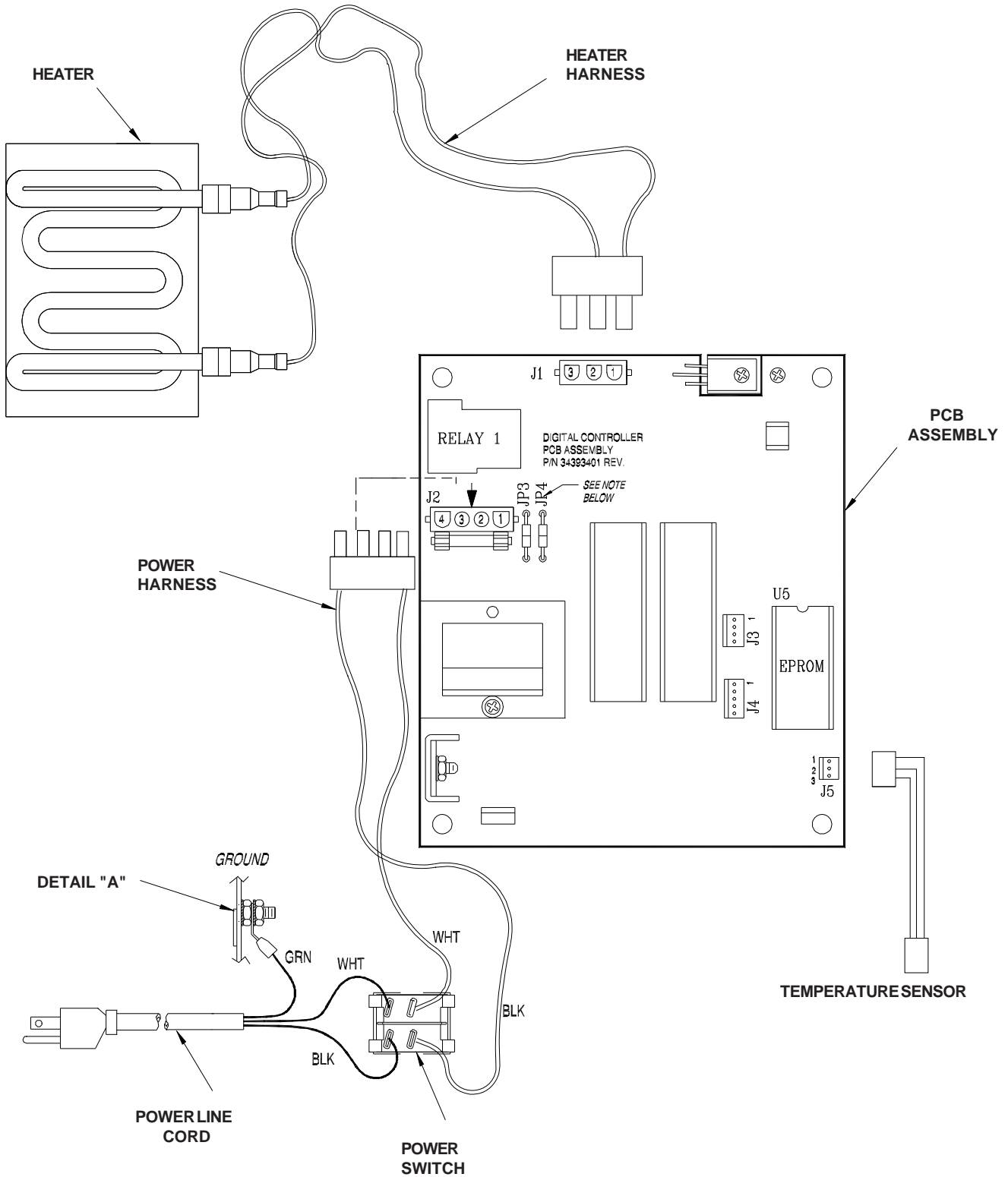

120 VAC WIRING DIAGRAM

NOTE: JP3 & JP4 MUST BE INSTALLED FOR 120 VAC OPERATION.

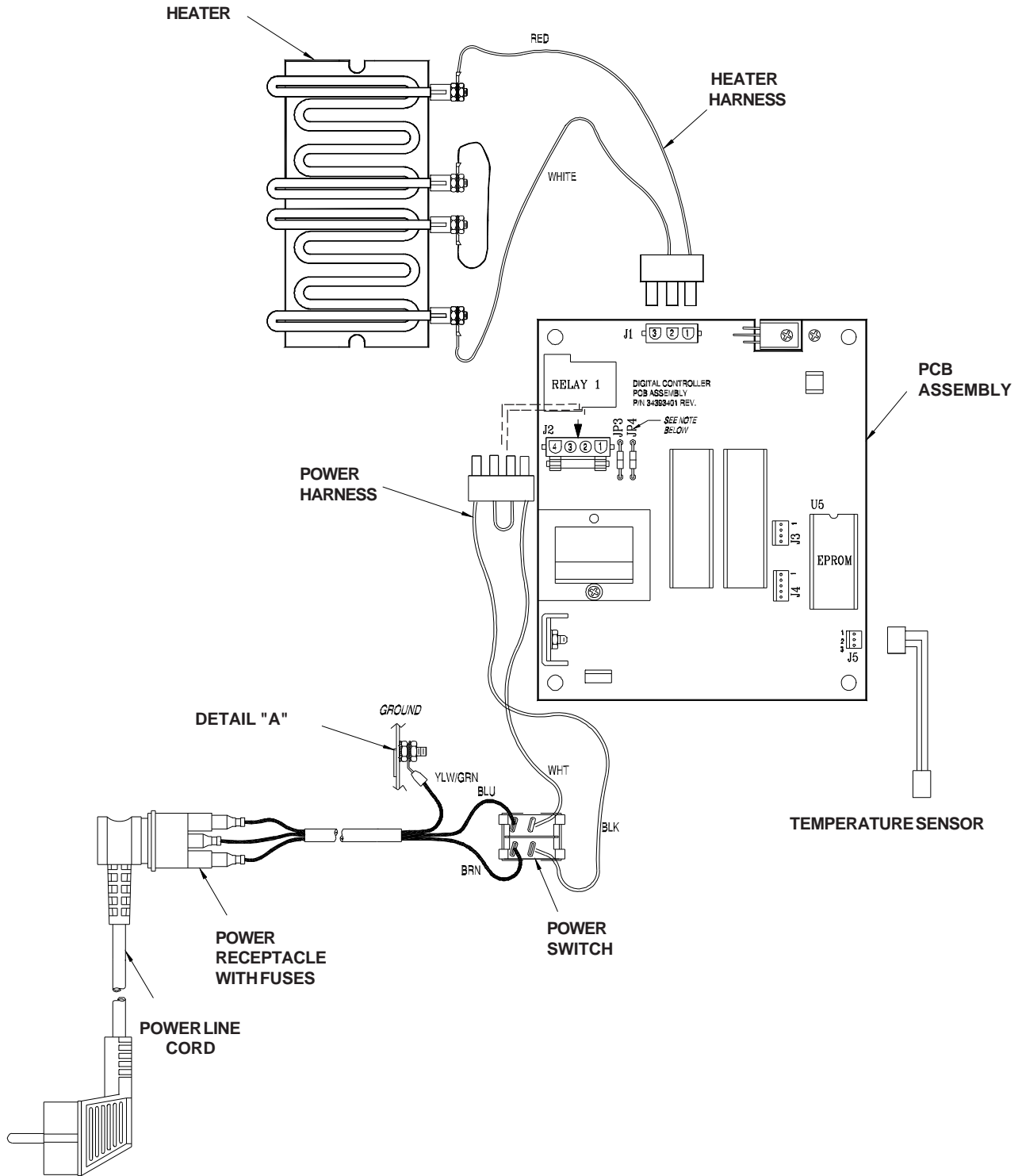

240 VAC WIRING DIAGRAM

NOTE: JP3 & JP4 MUST BE REMOVED FOR 240VAC OPERATION

THERMO FISHER SCIENTIFIC STANDARD PRODUCT WARRANTY

The Warranty Period starts two weeks from the date your equipment is shipped from our facility. This allows for shipping time so the warranty will go into effect at approximately the same time your equipment is delivered. The warranty protection extends to any subsequent owner during the first year warranty period.

During the first year, component parts proven to be non-conforming in materials or workmanship will be repaired or replaced at Thermo's expense, labor included. Installation and calibration are not covered by this warranty agreement. The Technical Services Department must be contacted for warranty determination and direction prior to performance of any repairs. Expendable items, glass, filters and gaskets are excluded from this warranty.

Replacement or repair of components parts or equipment under this warranty shall not extend the warranty to either the equipment or to the component part beyond the original warranty period. The Technical Services Department must give prior approval for return of any components or equipment. At Thermo's option, all non-conforming parts must be returned to Thermo Fisher Scientific postage paid and replacement parts are shipped FOB destination.

THIS WARRANTY IS EXCLUSIVE AND IN LIEU OF ALL OTHER WARRANTIES, WHETHER WRITTEN, ORAL OR IMPLIED. NO WARRANTIES OF MERCHANTABILITY OR FITNESS FOR A PARTICULAR PURPOSE SHALL APPLY. Thermo shall not be liable for any indirect or consequential damages including, without limitation, damages relating to lost profits or loss of products.

Your local Thermo Sales Office is ready to help with comprehensive site preparation information before your equipment arrives. Printed instruction manuals carefully detail equipment installation, operation and preventive maintenance.

If equipment service is required, please call your Technical Services Department at 1-800-438-4851 (USA and Canada) or 1-740-373-4763. We're ready to answer your questions on equipment warranty, operation, maintenance, service and special application. Outside the USA, contact your local distributor for warranty information.



Rev. 4 4/09

THERMO FISHER SCIENTIFIC INTERNATIONAL DEALER WARRANTY

The Warranty Period starts two months from the date your equipment is shipped from our facility. This allows for shipping time so the warranty will go into effect at approximately the same time your equipment is delivered. The warranty protection extends to any subsequent owner during the first year warranty period. Dealers who stock our equipment are allowed an additional six months for delivery and installation, provided the warranty card is completed and returned to the Technical Services Department.

During the first year, component parts proven to be non-conforming in materials or workmanship will be repaired or replaced at Thermo's expense, labor excluded. Installation and calibration are not covered by this warranty agreement. The Technical Services Department must be contacted for warranty determination and direction prior to performance of any repairs. Expendable items, glass, filters, reagents, tubing, and gaskets are excluded from this warranty.

Replacement or repair of components parts or equipment under this warranty shall not extend the warranty to either the equipment or to the component part beyond the original warranty period. The Technical Services Department must give prior approval for return of any components or equipment. At Thermo's option, all non-conforming parts must be returned to Thermo postage paid and replacement parts are shipped FOB destination.

THIS WARRANTY IS EXCLUSIVE AND IN LIEU OF ALL OTHER WARRANTIES, WHETHER WRITTEN, ORAL OR IMPLIED. NO WARRANTIES OF MERCHANTABILITY OR FITNESS FOR A PARTICULAR PURPOSE SHALL APPLY. Thermo shall not be liable for any indirect or consequential damages including, without limitation, damages relating to lost profits or loss of products.

Your local Thermo Sales Office is ready to help with comprehensive site preparation information before your equipment arrives. Printed instruction manuals carefully detail equipment installation, operation and preventive maintenance.

Contact your local distributor for warranty information. We're ready to answer your questions on equipment warranty, operation, maintenance, service and special application.



Rev. 4 2/09

