

How to Change Your Combination Universal Lock – Models 1310, 1330, 1380, 2230, 2236, 2280, 2286, 6310, 6330, 6380

NOTE: Your new combination will be determined at random. Once the combination has been changed, the limited warranty on the locking mechanism is voided.

TO CHANGE YOUR COMBINATION

1. To remove the cover panel from the inside of the door, remove the screw at the end. (Figure 1)

* DO NOT ADJUST OR REMOVE THE NUT HOLDING ON THE DRIVER.
(Figure 2)

2. On the outside of the door, turn the handle to release the locking bolt from the tumblers. The locking mechanism is assembled using either the first or second set of holes in the outer tumbler. Looking at the locking mechanism, push the tumblers down and away from you, until the posts on the bottom of the driver are completely out of the holes in the tumblers. (Figure 2)

3. Keeping the driver in place and the tumblers apart from it, turn the outer tumbler, until the other set of two holes are aligned with the posts on the driver. (Figure 3)

4. Release the tumblers. The driver posts should drop into the new holes. Turn the combination dial on the door front. As you do so, the driver and outer tumbler should move together.

TO RECORD YOUR NEW COMBINATION

1. On the door front, turn the combination dial counterclockwise at least three complete turns, then stop when the slot in the inner tumbler is aligned with the locking bolt bar (Figure 4). Record the number indicated on the combination dial: (A) _____

2. Now turn the combination dial clockwise until the slot in the middle tumbler is aligned with the locking bolt bar (Figure 5). Record the number indicated on the combination dial: (B) _____

3. Turn the combination dial counterclockwise only until the slot in the outer tumbler is aligned with the locking bolt bar (Figure 6). Record the number indicated on the combination dial: (C) _____

TEST YOUR COMBINATION WITH THE DOOR OPEN!

Test your new combination several times with the door open to make sure you have recorded it correctly. Then place the cover panel back in place on the inside of the door and fasten it with the screw. Your new combination is now ready to use.

LET US KEEP A COPY FOR YOU

Sentry will gladly keep your new combination in our confidential file, in case you lose or forget it. Simply mail the serial number of your safe, together with your new combination, to Sentry Customer Service at the address shown below.

Sentry Group • 900 Linden Avenue • Rochester, NY 14625-2784
Customer Service Department (800) 828-1438

ALWAYS KEEP YOUR SAFE LOCKED WHEN NOT IN USE.

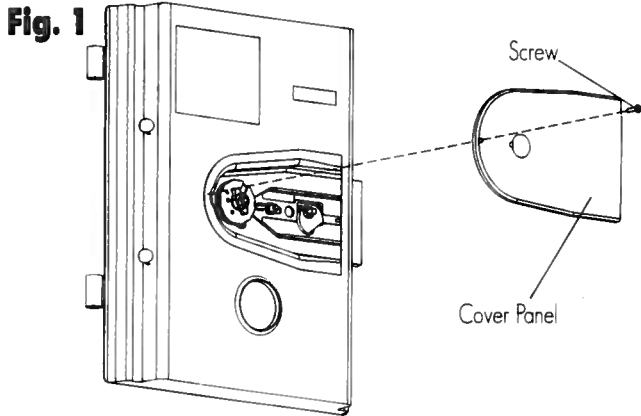

FRONT VIEW

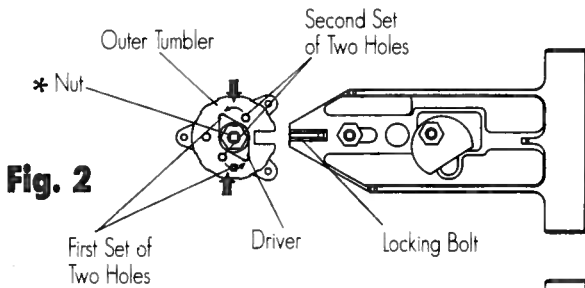
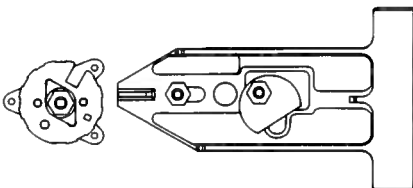

Fig. 2

Fig. 3



SIDE VIEW

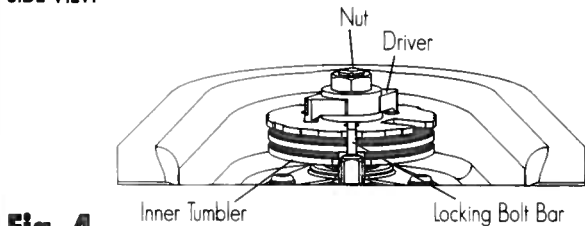

Fig. 4

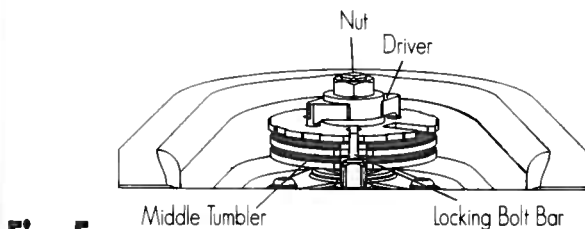

Fig. 5

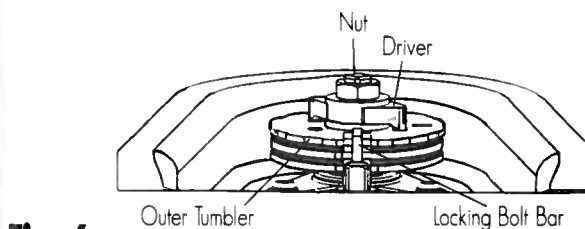
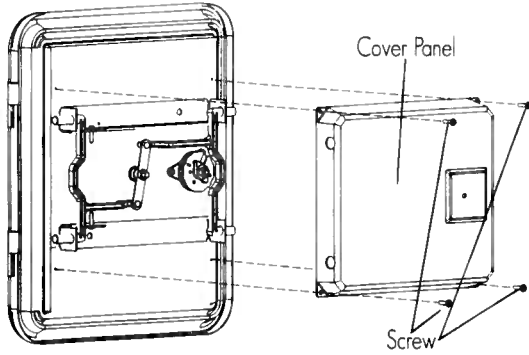

Fig. 6

Fig. 1



FRONT VIEW

Fig. 2

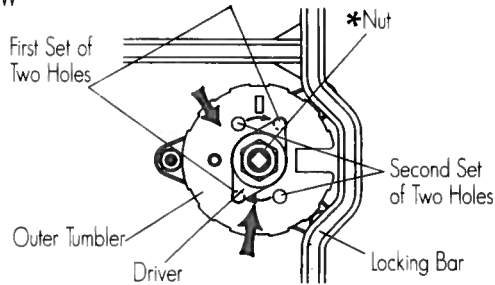
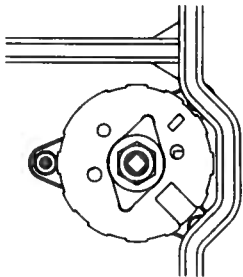

Fig. 3



SIDE VIEW

Fig. 4

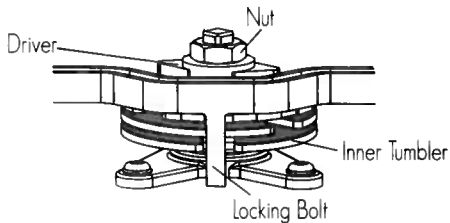

Fig. 5

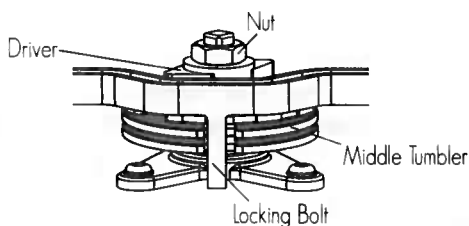
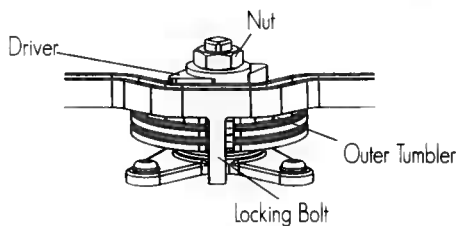

Fig. 6



How to Change Your Combination Universal Lock – Models 1200, 1250, 2200, 2206, 6250

NOTE: Your new combination will be determined at random. Once the combination has been changed, the limited warranty on the locking mechanism is voided.

TO CHANGE YOUR COMBINATION

1. To remove the cover panel from the inside of the door, remove the screws at each corner (4 total). (Figure 1)
*DO NOT ADJUST OR REMOVE THE NUT HOLDING ON THE DRIVER. (Figure 2)
2. On the outside of the door, turn the handle to release the locking bar from the tumblers. The locking mechanism is assembled using either the first or second set of holes in the outer tumbler. Looking at the locking mechanism, push the tumblers down and away from you, until the posts on the bottom of the driver are completely out of the holes in the tumblers. (Figure 2)
3. Keeping the driver in place and the tumblers apart from it, turn the outer tumbler, until the other set of two holes are aligned with the posts on the driver. (Figure 3)
4. Release the tumblers. The driver posts should drop into the new holes. Turn the combination dial on the door front. As you do so, the driver and outer tumbler should move together.

TO RECORD YOUR NEW COMBINATION

1. On the door front, turn the combination dial counterclockwise at least three complete turns, then stop when the slot in the inner tumbler is aligned with the locking bolt (Figure 4). Record the number indicated on the combination dial: (A) _____
2. Now turn the combination dial clockwise until the slot in the middle tumbler is aligned with the locking bolt (Figure 5). Record the number indicated on the combination dial: (B) _____
3. Turn the combination dial counterclockwise only until the slot in the outer tumbler is aligned with the locking bolt (Figure 6). Record the number indicated on the combination dial: (C) _____

TEST YOUR COMBINATION WITH THE DOOR OPEN!

Test your new combination several times with the door open to make sure you have recorded it correctly. Then place the cover panel back in place on the inside of the door and fasten it with the four screws. Your new combination is now ready to use.

LET US KEEP A COPY FOR YOU

Sentry will gladly keep your new combination in our confidential file, in case you lose or forget it. Simply mail the serial number of your safe, together with your new combination, to Sentry Customer Service at the address shown below.

Sentry Group • 900 Linden Avenue • Rochester, NY 14625-2784
Customer Service Department (800) 828-1438

ALWAYS KEEP YOUR SAFE LOCKED WHEN NOT IN USE.