

Quick Start Guide: Ultra-Low Temperature Upright Freezers



Before starting up your freezer, be sure to follow the instructions in your user manual regarding location, leveling, and clearance for airflow. The user manual is packaged in a plastic bag inside the cabinet, along with the key for the key switch.

Have a qualified technician verify that your supply voltage and amperage match the ratings on the dataplate located on the rear of the freezer. The unit may require a dedicated power line.

The following quick start instructions apply to standard freezers *without* the CO₂/LN₂ backup option. *If you have a backup system installed, follow the instructions in Quick Start Guide 314098H12 instead.*

1. Remove the front panel at the lower left and turn on the Battery Enable switch. Replace the panel.

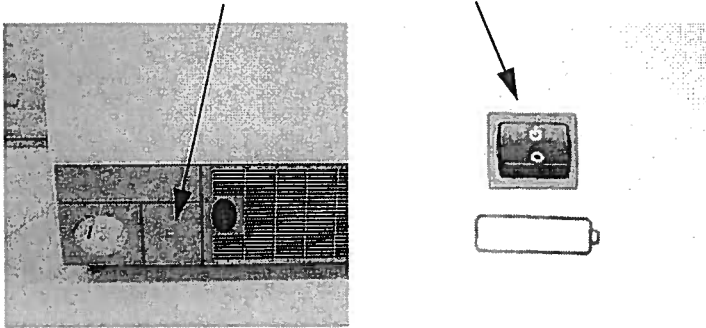

Front Panel, Battery Enable Switch

2. Turn on the main AC power switch at the rear of the unit.



Power Switch

3. Turn the key switch on the control panel to the POWER ON position.

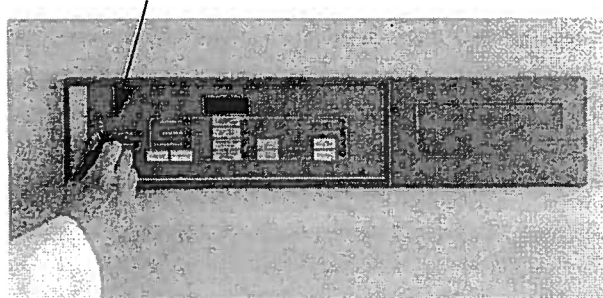

Control Panel with Key Switch

The default temperature setpoint is -80°C . Refer to the user manual for instructions on how to adjust temperature setpoint and other settings.

Removing the Freezer from the Shipping Pallets



CAUTION! This freezer is heavy. Be sure you have enough personnel moving the freezer to prevent tipping.

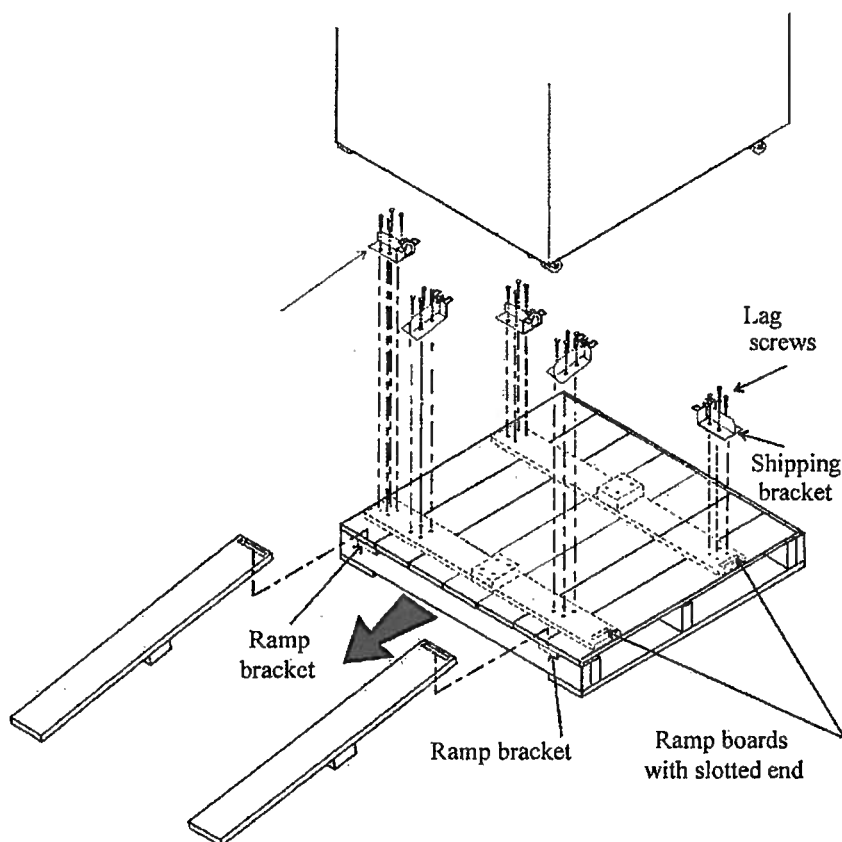

To remove the freezer from the shipping pallets:

1. Remove and discard the shipping plastic.
2. Using a 1/2" combination wrench and phillips, remove all screws securing the shipping brackets to the pallet.
3. Discard all shipping brackets.
4. Remove the ramp boards from the shipping pallet and locate the slotted end over the ramp brackets with the support blocks on the underside.
5. Align the casters with the ramp boards.
6. Be sure to use enough personnel to roll the freezer off the pallet. Brace the pallet on the opposite side to prevent tipping.

Quick Start Guide: Ultra-Low Temperature Upright Freezers



Before starting up your freezer, be sure to follow the instructions in your user manual regarding location, leveling, and clearance for airflow. The user manual is packaged in a plastic bag inside the cabinet, along with the key for the key switch.

Have a qualified technician verify that your supply voltage and amperage match the ratings on the dataplate located on the rear of the freezer. The unit may require a dedicated power line.

The following quick start instructions apply to standard freezers *without* the CO₂/LN₂ backup option. *If you have a backup system installed, follow the instructions in Quick Start Guide 314098H12 instead.*

1. Remove the front panel at the lower left and turn on the Battery Enable switch. Replace the panel.

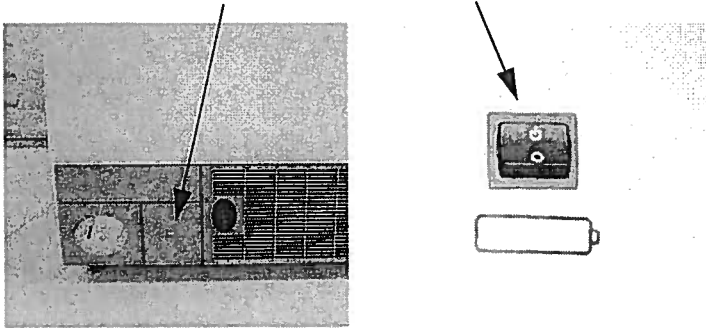

Front Panel, Battery Enable Switch

2. Turn on the main AC power switch at the rear of the unit.

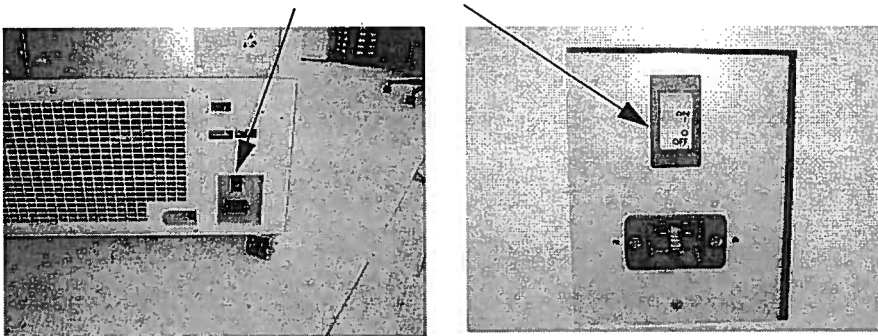

Power Switch

3. Turn the key switch on the control panel to the POWER ON position.

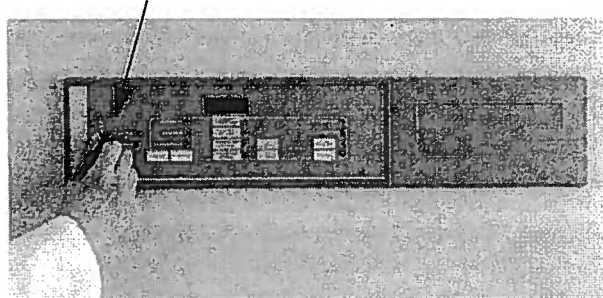

Control Panel with Key Switch

The default temperature setpoint is -80°C . Refer to the user manual for instructions on how to adjust temperature setpoint and other settings.

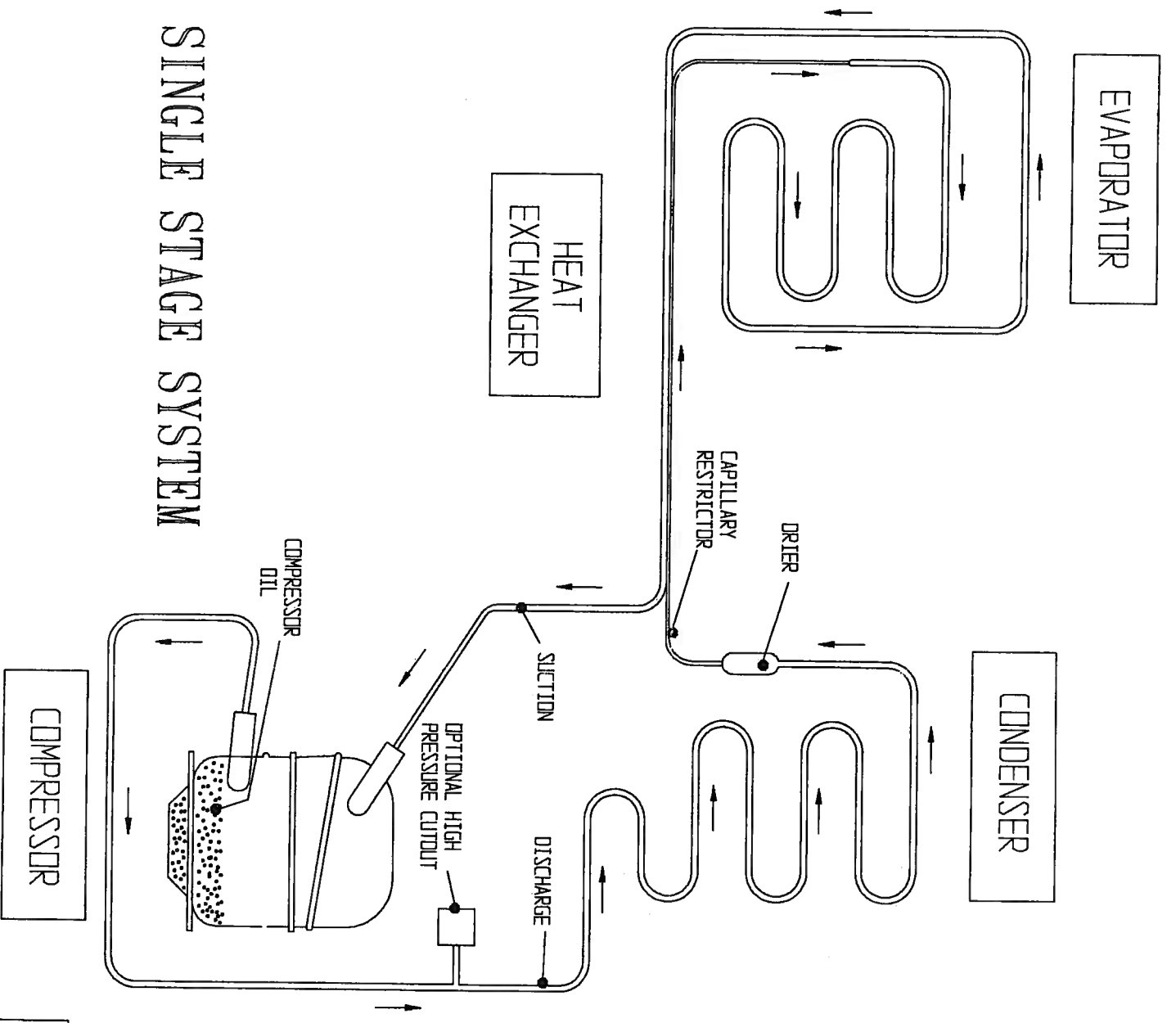

SINGLE STAGE SYSTEM

COMPRESSOR

EVAPORATOR

CONDENSER

HEAT EXCHANGER

REFRIGERATION DIAGRAM
A 89268 H16

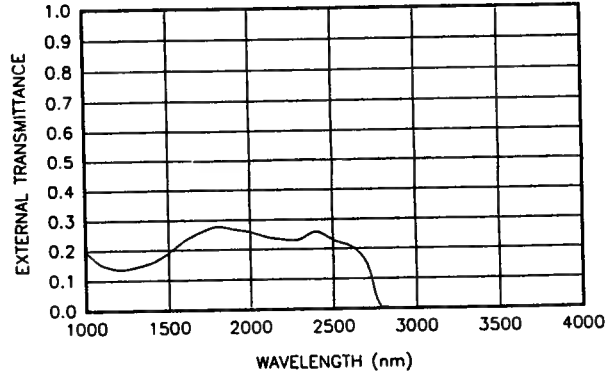
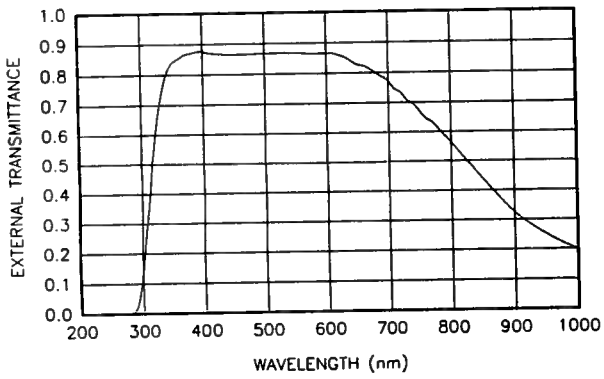

250 LONG BEACH BLVD., P.O. BOX 872, STRATFORD, CT. U.S.A. 06497 ■ TEL. (203) 377-8282 ■ TLX 4750361 ■ FAX (203) 378-2457

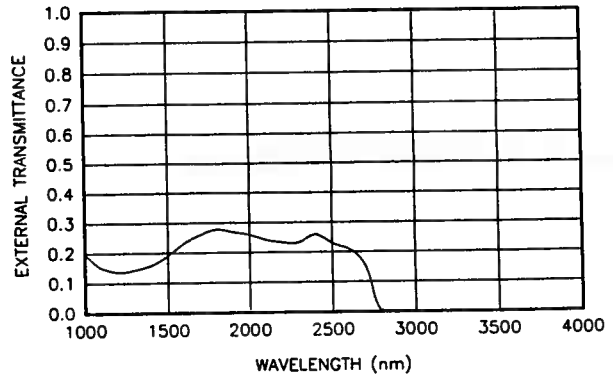
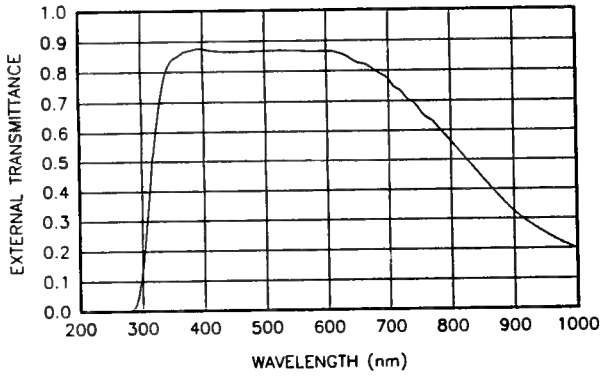

250 LONG BEACH BLVD., P.O. BOX 872, STRATFORD, CT. U.S.A. 06497 ■ TEL. (203) 377-8282 ■ TLX 4750361 ■ FAX (203) 378-2457