



SERIES 120

USER'S GUIDE

EXFO

X-Cite 120 User's Guide

©EXFO Photonic Solutions Inc., 2002

All rights reserved

No part of this publication may be reproduced, transmitted, transcribed, stored in a retrieval system or translated into any language in any form by any means without the prior written consent of EXFO Photonic Solutions Inc. Every effort has been made to insure information in this manual is accurate, however, information in this manual is subject to change without notice and does not represent a commitment on the part of the authors.





Trademarks

X-Cite® and Intelli-Lamp® are registered trademarks of EXFO Photonic Solutions Inc. All other product names are trademarks of their respective owners.

Table of Contents

| | | |
|-----------|--|-----------|
| 1 | X-Cite 120 Message Reference | 2 |
| 2 | Introduction | 3 |
| 3 | Checking the contents of the box | 4 |
| 3.1 | Front Panel | 5 |
| 3.2 | Rear Panel | 5 |
| 4 | Safety Precautions..... | 6 |
| 5 | Installing the Lamp Module | 9 |
| 6 | Inserting and Removing the Light Guide..... | 13 |
| 7 | Installing the Collimating Adapter..... | 14 |
| 8 | Powering Up and Powering Down | 15 |
| 9 | Viewing the Accumulated Lamp Hours..... | 15 |
| 10 | Adjusting the Illumination (Optional) | 16 |
| 11 | Troubleshooting..... | 17 |
| 12 | Technical Specifications | 19 |
| 12.1 | Lamp module..... | 19 |
| 12.2 | Light guide | 20 |
| 12.3 | Power Input | 21 |
| 12.4 | Lamp power (electrical)..... | 21 |
| 12.5 | Environmental Specifications:..... | 22 |
| 12.6 | Regulatory Compliance..... | 23 |
| 13 | Contact Information..... | 25 |
| 13.1 | Service Contacts | 26 |

1 X-Cite 120 Message Reference

| Symbol | Message | Description |
|--|---------------------------------------|---|
| XXXX H | Lamp Hours | Displays the accumulated hours the lamp has been on |
|  | Constant bulb | The lamp is on and ready for use |
|  | Flashing bulb | Lamp is striking or warming up (90 sec.) |
|  | Constant bulb with no symbol | No lamp detected or lamp is 4000+ hrs old. |
|  | Constant bulb with flashing no symbol | The lamp is 2000 - 4000 hours old. Replace lamp. |
|  | Flashing bulb with constant no symbol | The lamp did not strike or is too hot to strike. |

See Section 11 for Troubleshooting.

2 Introduction

The X-Cite Series 120 represents a new standard in fluorescence illumination. It gives you the convenience and control never before available in a fluorescence illuminator and has been designed to let you focus your energy where it belongs, on obtaining the best possible results. The X-Cite 120 joins the EXFO Life Sciences & Industrial Division family of light systems offering the same high level of innovation, quality and reliability that our commercial customers have come to expect. Since 1982, EXFO Life Sciences & Industrial Division has combined next generation optical engineering, state-of-the-art electronics and fibre-optics to produce sophisticated technologies that employ light. Today EXFO Life Sciences & Industrial Division is a leading developer of light based systems for sectors ranging from manufacturing to bio-medicine and we are unmatched in our commitment to quality and service.

The heart of the X-Cite120 is a proprietary 120-watt short arc lamp with an improved 2000-hour typical lifetime. This extended lifetime is made possible by the proprietary thermal management system incorporated into the design. The lamp is mounted in an elliptical reflector with a proprietary coating to provide unequalled spectral and power output. The new X-Cite Series 120 has also been improved for much quieter operation. Standard features incorporated in the X-Cite 120 include: the pre-aligned Intelli-Lamp[®] system, an accumulative lamp hour meter and a lamp status indicator.

The X-Cite 120 is a high quality product manufactured in accordance with ISO 9001, CE marked and certified to UL and CSA standards.

We suggest that you read this manual to discover all features, and how to use them.

3 Checking the contents of the box

1. Carefully unpack the unit and accessories.
2. Store the packing material for future use.

Box Contents

1. The X-Cite 120 illumination unit



2. The X-Cite 120 lamp module



3. Collimating Adapter



4. X-Cite 120 Light guide
(3mm x 1.5m or 3mm x 3.0m)



5. Grounded power cord (IEC)
6. Hex Key, 3mm (Lamp access cover)
7. X-Cite 120 Users guide

If your packaged unit is missing any of the above components, call EXFO Life Sciences & Industrial Division at (418) 683-0211 or TOLL FREE 1-800-663-3936.

Any additional optional items purchased to customize the unit will also be present.

3.1 Front Panel



3.2 Rear Panel



4 Safety Precautions

The X-Cite 120 is equipped with two safety sensors to protect the user from accidental UV exposure. In addition, please observe the following precautions during use. This series of cautions, warnings and dangers relate to the operation and maintenance of the X-Cite 120. They are also presented throughout this User's Guide where necessary.



Warning

Eye damage may result from directly viewing the light produced by the lamp used in this product. Always use protective eyewear and turn the lamp off before removing cover.



Caution

Never look into the light emitting end of the light guide. The light could severely damage the cornea and retina of the eye if the light is observed directly. Eye shielding must be used at all times as well as clothing to protect exposed skin.



Warning

Always make sure the light guide is properly inserted into the X-Cite 120 and the microscope prior to turning on power to the unit. This will minimize the risk of exposure to the UV light.



Caution!

To prevent damage/ degradation of the light guide, always allow adequate clearance at the rear of the X-Cite unit to prevent kinking or excessive bending.



Warning

To reduce the risk of fire or shock, always replace the fuses with the same type and rating.



Warning

Disconnecting of mains supply source is only possible by unplugging the attachment plug.



Warning

This unit is designed for bench top use only! Always ensure that the unit is operated on a hard, stable surface. This will prevent obstruction of the bottom chassis ventilation openings. Any obstruction of these openings could result in a possible over-heating condition. Do not attempt to remove or tamper with the rubber feet located on the bottom of the unit.

**Danger**

This unit contains HIGH VOLTAGE components. It is recommended that ONLY QUALIFIED TECHNICAL PERSONNEL perform any testing or repairs described in this manual. Disconnect the AC power cord from the unit before opening the cover of this unit. All cover screws must be replaced prior to applying power to the unit, or safety of the unit will be impaired.

**Monitoring the unit during manual operation**

The level of UV energy supplied by the X-Cite 120 is sufficient to ignite flammable substances. During manual operation, the unit must be attended at all times by a qualified operator. The unit must not be left unattended while turned on. If an operator leaves the work area of the unit, the lamp power switch must be turned off.

**Monitoring the unit during automated operation**

The level of UV energy supplied by the X-Cite 120 is sufficient to ignite flammable substances. Therefore, when the unit is operated unattended in an automated environment, an alarm function must be provided by the user to indicate a malfunction in the associated equipment used.

**Warning**

Hg – LAMP CONTAINS MERCURY, Manage in Accord with Disposal Laws, see: www.lamprecycle.org or 1-800-668-8752

**Danger**

When unpacking or installing the lamp, always wear protective clothing and a face mask. Operate lamp only in the X-Cite 120 lamp housing. This prevents direct viewing of the arc and in the case of lamp bursting, contains lamp particles. In the rare instance in which a lamp bursting occurs, and the mercury content is released, the following safety precautions are recommended: All personnel should be immediately evacuated from the area to prevent inhalation of the mercury vapour. The area should be well ventilated for a minimum of 30 minutes. After the lamp housing elements have cooled, the mercury residue should be collected with the use of a special absorbing agent available from laboratory equipment suppliers.

**Warning**

Should this X-Cite 120 unit be used in a manner not specified by EXFO Life Sciences & Industrial Division, the protection provided by the equipment may be impaired.

**Warning**

The method in which lamps are disposed of must comply with local rules & regulations for disposal of hazardous materials. Lamps may be returned to EXFO Life Sciences & Industrial Division providing they are returned in its original packaging. EXFO Life Sciences & Industrial Division will dispose of them in the appropriate manner.

**Caution**

The lamp module's operational life can be significantly shortened if it is handled incorrectly. Do not touch the bulb's glass envelope or the inside surface of the reflector. Skin oils can cause the lamp module to fail prematurely.

**Caution**

Prior to opening the unit and handling the lamp module, allow the lamp module to cool down completely.

**Caution**

Any electronic equipment connected to the X-Cite 120 must be IEC950 certified.

**Cleaning:**

Clean exterior of the unit with a water dampened cloth and simple detergent only.

5 Installing the Lamp Module

1. Be sure the AC power cord is disconnected from the unit.
2. Remove the screw from the lamp housing side panel and remove the panel from the unit cover.



3. Carefully remove the lamp module from its container, holding only the ceramic components.



Caution!

The lamp module's operational life can be significantly shortened if handled incorrectly. Be sure only to handle the ceramic surfaces. Do not touch the bulb's glass envelope or the inside surface of the reflector. Skin oils can cause the lamp module to fail prematurely.

4. Open the lamp bracket arm by pulling towards you.



Position the lamp so that the two leading edges of the lamp ceramic mount slide into the groove of the lamp bracket. The middle of the lamp should be in position to fit into the spring clamp.

Tip: Make sure that the "This side out" label is facing outwards before trying to insert the lamp

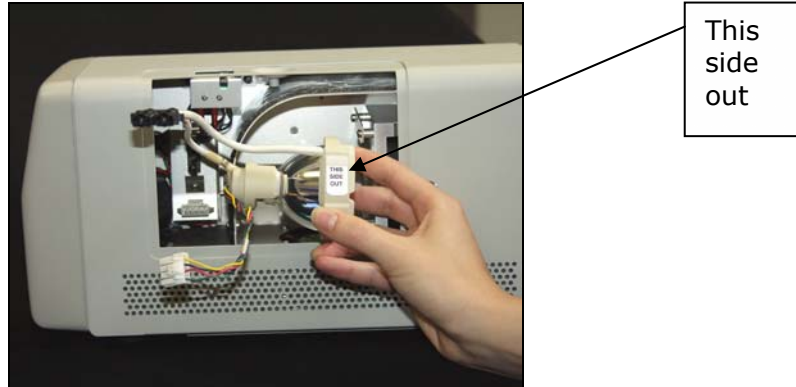

5. Slide the lamp all the way in so that both leading edges of the lamp ceramic mount are in the groove of the lamp bracket. The middle of the lamp will snap into the spring clamp. Close the lamp bracket arm.
6. Locate the 4-pin Intelli-Lamp sensor connector at the rear of the lamp module and connect it to its mate located on the lamp-housing wall.

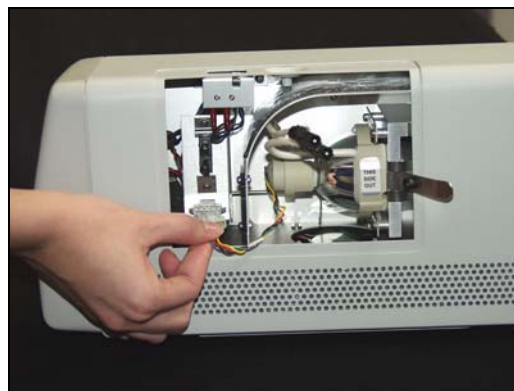

Tip: the Intelli-lamp connector will only attach in the correct orientation. If you are having difficulty attaching the connector, try rotating it by 180°

-
7. Attach the 2-pin lamp power connector to its mate on the lamp-housing wall.



Tip: the 2-pin lamp power connector will only attach in the correct orientation. If you are having difficulty attaching the connector, try rotating it by 180°

8. Secure the Intelli-Lamp and power wires into the grooves of the lamp housing.



-
9. Replace the lamp housing side panel and tighten the fastening screw.

Note: *if the lamp is not installed correctly, the constant lamp with a "no" symbol will display when power is turned on to the unit.*



Warning

This unit is designed for bench top use only! Always ensure that the unit is operated on a hard, stable surface. This will prevent obstruction of the bottom chassis ventilation openings. Any obstruction of these openings could result in a possible over-heating condition. Do not attempt to remove or tamper with the rubber feet located on the bottom of the unit.

6 Inserting and Removing the Light Guide

1. Make sure that power is off to the X-Cite 120 unit.
2. Ensure that the protective end caps are removed from both the input and output ends of the light guide prior to installation.
3. Insert the light guide into the light guide retainer located on the back panel of the unit. Push the light guide in until it seats with a second positive "click".



Tip: When the light guide is fully inserted, the line on the light guide insertion label will be right up against the light guide port.

Note: the light intensity through the light guide will be reduced if the light guide is not inserted properly.

4. During installation or removal, grasp the light guide on the strain-relief nearest the input end of the light guide.
Note: never grip the light guide during installation or removal in a place other than the strain relief portion of the light guide.
4. To remove the light guide, firmly grip the strain relief near the light guide retainer and pull out firmly.

Note: the X-Cite 120 is designed for use with a 3mm liquid light guide. EXFO Life Sciences & Industrial Division can not guarantee the performance of the X-Cite if using light guides other than those supplied by EXFO Life Sciences & Industrial Division.

Caution!

To prevent damage/ degradation of the light guide, always allow adequate clearance at the rear of the X-Cite unit to prevent kinking or excessive bending.

7 Installing the Collimating Adapter

1. Make sure power is off to the X-Cite 120 unit.
2. The existing lamp housing must be removed from the microscope before the collimating adapter can be mounted. Do not discard the existing mounting hardware, since it will be used to secure the collimating adapter to the microscope.
5. Remove the collimating adapter from its packaging.

Note: *the collimating adapter has been set at the factory. No adjustments by the customer are required.*

6. Insert the flange portion of the collimating adapter into the lamp port of the microscope. Using the existing hardware, tighten the screw(s) until the flange is fully secured.

Note: *the installation of the collimating adapter will vary with microscope models.*

5. Remove the protective cap from the output end of the light guide. Insert the light guide into the input portion of the collimating adapter until it is flush with the adjustable insert. Secure the light guide to the collimating adapter by tightening the thumbscrew. Do not over tighten.

Note: *the light guide has a bend radius of 1.6 inches (40.0mm). Exceeding this radius will result in permanent damage to the light guide.*

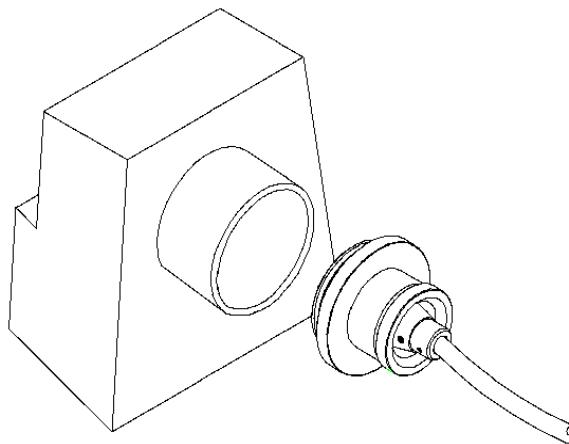

Warning!

Turning power on to the X-Cite 120 unit without the light guide properly installed in the unit and in the microscope can increase your risk of exposure to UV light

8 Powering Up and Powering Down

1. Plug the X-Cite 120 unit into a properly grounded AC outlet.
2. Ensure that the lamp and light guide have been properly installed and that the cover is securely fastened.



Warning!

Turning power on to the X-Cite 120 unit without the light guide properly installed in the unit and in the microscope can increase your risk of exposure to UV light

3. Turn on the mains power switch, located on the front panel and check the fan for airflow.
4. The lamp indicator will illuminate, and the display will flash for the warm up period of 90 seconds. During the warm up period, it is still possible to view the accumulated lamp hours. Wait for the warm up period to finish before using the X-Cite 120 on an application.

Note: Unit should not be turned off unless the lamp has been on for a minimum of five minutes.

Note: If the lamp is turned off, and an attempt is made to turn it back on before it has fully cooled, the flashing bulb with the "no" symbol may appear on the display. The lamp will automatically restrike when the lamp has cooled.



5. To power down the unit, turn off the mains power switch, located on the front panel.

9 Viewing the Accumulated Lamp Hours

The accumulated lamp hours are continuously shown on the LCD display on the front panel of the unit. The lamp hours are automatically updated.

10 Adjusting the Illumination (Optional)

If your X-Cite 120 system includes the optional iris adjustment, then it is possible to manually change the amount of illumination out of the unit.

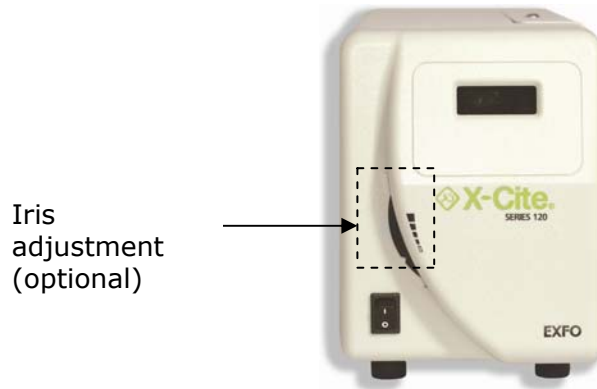

The iris adjustment includes 5 different illumination settings.

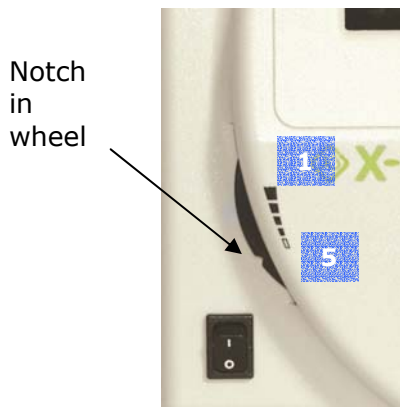

1. 100% of the total illumination
2. 50% of the total illumination
3. 25% of the total illumination
4. 12% of the total illumination
5. 0% of the total illumination

Note: Settings levels are approximate values

To increase the amount of illumination from the unit

1. Turn the iris adjustment wheel upward to increase the illumination to the next setting.
2. The notch in the iris adjustment wheel shows the current setting of the iris.

To decrease the amount of illumination from the unit

1. Turn the iris adjustment wheel downward to decrease the illumination to the next setting.
2. The notch in the iris adjustment wheel shows the current setting of the iris

11 Troubleshooting



Service to be completed by qualified repair personnel only!

If the unit fails to power up or function properly, use the following checklist to eliminate the most common causes of problems. Check that:



1. The AC power cord is securely plugged into a functional AC wall plug.
2. The AC power cord is securely plugged into the AC inlet on the rear of the unit.



3. The mains AC power switch is in the ON position.
4. Check that the ventilation openings both on the bottom and rear of the unit are not blocked.

If the LCD display lights and the fan starts, but the lamp won't turn on, check that:

1. The LCD display indicates the constant bulb with the "no" symbol. This indicates that no lamp is detected. Check if the lamp has been installed correctly. Refer to section 5 – Installing the Lamp Module. 

2. The lamp may have reached the end of life. Power down the unit, wait a few minutes and turn power on to the unit. If it still does not strike, replace the lamp.

Note: *If lamp life has reached 4,000 hours, it is necessary to replace the lamp module.*

3. The LCD display indicates the flashing bulb with the constant "no" symbol. This indicates the lamp did not strike. If the lamp was just recently turned off, it may be too hot to strike. The lamp will automatically strike when it has cooled. 

4. The LCD display indicates the flashing bulb for 90 sec. to show lamp warming, then indicates the flashing bulb with the "no" symbol. This indicates that the lamp housing panel is not secured properly in place. Remove the lamp housing panel and replace securely, tightening the fastening screw in place. 

If the light intensity is too low, check that:

1. The light guide has been fully inserted into the light guide retainer.
2. If the X-Cite 120 unit includes the optional iris adjustment, turn the adjustment wheel upward to increase the illumination. See section 10 – Adjusting the Illumination
3. There are no foreign substances on the emitting end of the light guide.
4. There are no bends, kinks, or other physical damage to the guide. Replace the guide if there is any physical damage.

-
5. The lamp has been installed correctly. See section 5 – Installing the Lamp Module.

It may be necessary to replace the lamp or to replace the light guide. Contact your sales representative for information on purchasing a new lamp or light guide.

If the LCD display does not light:

1. If the fan is functional, power down the unit, wait approximately 20 seconds then power it up again
2. If the problem persists, contact your local sales representative.

If the Fan does not work properly

1. If the LCD display is functional, power down the unit, wait approximately 20 seconds then power it up again
2. If the problem persists, contact your local sales representative.

12 Technical Specifications

12.1 Lamp module

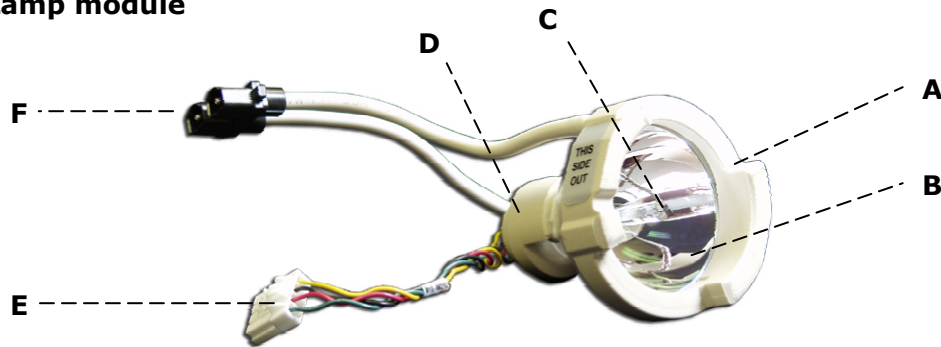

A, D: Ceramic Components. **B:** Reflector. **C:** Bulb.
E: Intelli-Lamp Connector. **F:** Lamp Power Connector

| | |
|-------------------------|---|
| Lamp Module | High Pressure 120 Watt metal halide short arc |
| Lamp Module Life | 2000 hours (typical) |
| Warm Up | 90 seconds (typical) |

12.2 Light guide

Light Delivery

Flexible liquid filled light guide 1.5m or 3m in length with a core diameter of 3mm. Custom light guides are also available.

Liquid Light Guide End Fitting

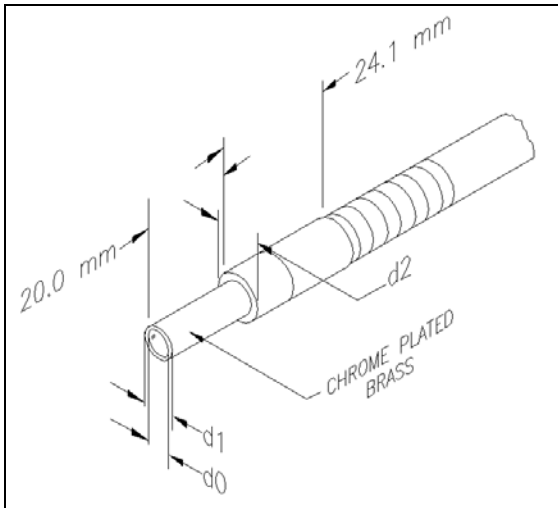

Liquid Light Guide Dimensions in mm

| Core | End Fitting | End Fitting | Minimum Bend Radius(mm) |
|------|-------------|-------------|-------------------------|
| d0 | d1 | d2 | |
| 3 | 5 | 9 | 40 |

12.3 Power Input

| | |
|-----------------------|--|
| Power Supply: | High efficiency, switch mode, constant power output |
| Input Voltage: | 100-240V, 50/60Hz |
| Current: | 2.4 – 1.0A (100/ 240V) |
| Input Surge: | 50A max. (cold start) |
| Protection: | Short circuit protection Overvoltage (up to 135%, +/- 5% of nominal) EMI filtering integrated into the PFC module Lamp driver circuit has integrated thermal cutoff |
| Fuse Rating: | Dual fuse system: each fuse rated at F4A 250V (Fast acting type) |

12.4 Lamp power (electrical)

| | |
|------------------------------|--|
| Lamp Voltage: | 85V RMS, square wave, 50% duty cycle, 1.4A typical |
| Output Power: | Lamp: nominal 120W |
| Max. Lamp Voltage: | 115V RMS |
| Lamp Drive Frequency: | 150Hz |
| Line Regulation: | From min Vin to max Vin lamp: +/-2% |

12.5 Environmental Specifications:

Operating Conditions

| | |
|-------------------------------|-------------------------------|
| Operating Temperature: | 5 to 40°C |
| Altitude: | 2000m max. |
| Humidity: | 15 to 90% RH (non-condensing) |
| Atmospheric Pressure: | 70 to 106 kPa |
| Overvoltage Category: | II |
| Pollution Degree: | 2 |

Transport and Storage Conditions

| | |
|------------------------------|-------------------------------|
| Temperature: | -10 to +70°C |
| Relative Humidity: | 10 to 95% RH (non-condensing) |
| Atmospheric Pressure: | 50 to 106 kPa |

12.6 Regulatory Compliance



Complies to the following directives / standards

| | |
|--|--|
| Council Directive 72/23/EEC | Low Voltage Directive |
| Council Directive 89/336/EEC | EMC Directive |
| <i>Safety Compliance:</i> | |
| EN/IEC 61010-1:2001 | Safety Requirements for electrical equipment for measurement, control and laboratory use Part 1: General requirements |
| CAN/CSA 1010.1-1992 | Safety Requirements for Electrical Equipment for Measurement, Control and Laboratory Use, Part I: General Requirements |
| UL Std No. 61010A-1 | Electrical Equipment for Laboratory Use, Part I: General requirements |
| <i>Electromagnetic Compatibility:</i> | |
| EN 61326:1997 + A1:1198+A2:2001 (IEC 61326:2002) | Electrical Equipment for Measurement, Control and Laboratory Use- Electromagnetic Compatibility |

FCC Class A Digital Device or Peripheral – Information to User

NOTE: *This equipment has been tested and found to comply with the limits for a Class A digital device, pursuant to Part 15 of the FCC Rules. These limits are designed to provide reasonable protection against harmful interference when the equipment is operated in a commercial environment. This equipment generates, uses, and can radiate radio frequency energy and, if not installed and used in accordance with the instruction manual, may cause harmful interference to radio communications. Operation of this equipment in a residential area is likely to cause harmful interference in which case the user will be required to correct the interference at his own expense.*

Warning: *Changes or modifications not expressly approved by EXFO Life Sciences & Industrial Division could void the user's authority to operate the equipment.*

WEEE Directive (2002/96/EC)



The symbol above indicates that this product should not be disposed of along with municipal waste, that the product should be collected separately, and that a separate collection system exists for all products that contain this symbol within member states of the European Union.

- The equipment that you bought has required the extraction and use of natural resources for its production. It may contain hazardous substances that could impact health and the environment.
- In order to avoid the dissemination of those substances in our environment and to diminish the pressure on the natural resources, we encourage you to use the appropriate take-back systems. Those systems will reuse or recycle most of the materials of your end life equipment in a sound way.
- The crossed-out wheeled bin symbol indicated above invites you to use those systems.
- If you need more information on the collection, reuse and recycling systems, please contact your local or regional waste administration.

13 Contact Information

EXFO Life Sciences & Industrial Division

Tel: (905) 821-2600

Fax: (905) 821-2055

1-800-668-8752 (*USA and Canada*)

xcite@exfo.com

www.exfo-xcite.com

13.1 Service Contacts

Service information may be obtained by contacting your nearest X-Cite Service Centre:

EXFO Life Sciences & Industrial Division 1-800-668-8752 (*USA and Canada*)
2260 Argentia Rd.
Mississauga, Ontario L5N 6H7
CANADA Tel: (905) 821-2600
Fax: (905) 821-2055
techsupport.exfo.psi@exfo.com
www.exfo-xcite.com

EXFO Asia Pacific Tel: +861 068 492 738
Room 1754 Office Tower
Beijing New Century Hotel
Number 6 Southern Capitol Gym Road
Beijing 100044
CHINA Fax: +861 068 492 662
beijing.service@exfo.com

EXFO Europe Tel: +33 1 40.83.85.85
Le Dynasteur 10-12, rue Andras Beck
92360 Meudon La Forêt Cedex
FRANCE Fax: +33 1 40.83.04.42
europe.service@exfo.com

Printed in Canada
035-00199 Rev. 3