



# LM119A/LM119/LM219/LM319A/LM319

## High Speed Dual Comparator

### General Description

The LM119 series are precision high speed dual comparators fabricated on a single monolithic chip. They are designed to operate over a wide range of supply voltages down to a single 5V logic supply and ground. Further, they have higher gain and lower input currents than devices like the LM710. The uncommitted collector of the output stage makes the LM119 compatible with RTL, DTL and TTL as well as capable of driving lamps and relays at currents up to 25 mA.

The LM119A and LM319A offer improved precision over the standard LM119 and LM319, with tighter tolerances on offset voltage, offset current, and voltage gain.

### Features

- Two independent comparators
- Operates from a single 5V supply

- Typically 80 ns response time at  $\pm 15V$
- Minimum fan-out of 2 each side
- Maximum input current of 1  $\mu A$  over temperature
- Inputs and outputs can be isolated from system ground
- High common mode slew rate

Although designed primarily for applications requiring operation from digital logic supplies, the LM119 series are fully specified for power supplies up to  $\pm 15V$ . It features faster response than the LM111 at the expense of higher power dissipation. However, the high speed, wide operating voltage range and low package count make the LM119 much more versatile than older devices like the LM711.

The LM119A and LM119 are specified from  $-55^{\circ}C$  to  $+125^{\circ}C$ , the LM219 is specified from  $-25^{\circ}C$  to  $+85^{\circ}C$ , and the LM319A and LM319 are specified from  $0^{\circ}C$  to  $+70^{\circ}C$ .

### Connection Diagrams

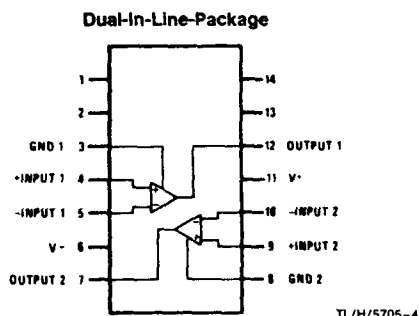

Top View

Order Number LM119AJ, LM119J, LM219J, LM319AJ, LM319J, LM319AM, LM319M, LM319AN or LM319N  
See NS Package Number J14A, M14A or N14A

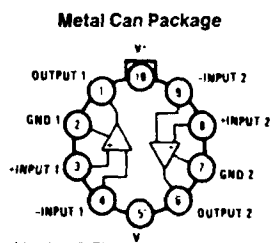

Top View

Order Number LM119AH, LM119H, LM319AH or LM319H  
See NS Package Number H10C

### Typical Applications\*

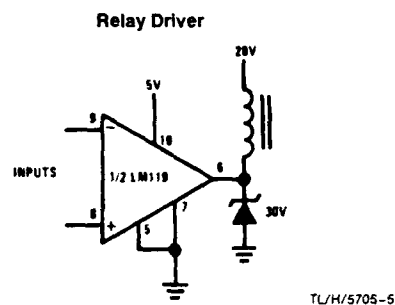

TL/H/5705-5

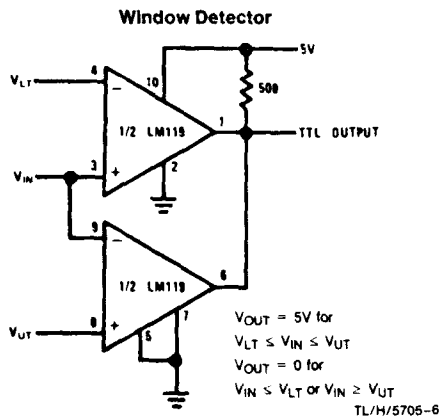

TL/H/5705-6

\*Pin numbers are for metal can package.

### Absolute Maximum

If Military/Aerospace specific please contact the National Office/Distributors for availability (Note 7)

- Total Supply Voltage
- Output to Negative Supply Voltage
- Ground to Negative Supply Voltage
- Ground to Positive Supply Voltage
- Differential Input Voltage
- Input Voltage (Note 1)
- ESD rating (1.5 k $\Omega$  in series with)
- Power Dissipation (Note 2)
- Output Short Circuit Duration

### Electrical Characteristics

Parameter
Input Offset Voltage (Note 4)
Input Offset Current (Note 4)
Input Bias Current
Voltage Gain
Response Time (Note 5)
Saturation Voltage
Output Leakage Current
Input Offset Voltage (Note 4)
Input Offset Current (Note 4)
Input Bias Current
Input Voltage Range
Saturation Voltage
Output Leakage Current
Differential Input Voltage
Positive Supply Current
Negative Supply Current

Note 1: For supply voltages less than 5V.  
 Note 2: The maximum junction temperature in the H10 package must be derated. J14 package is 100°C/W, junction.  
 Note 3: These specifications apply however, all temperature specific values from a single 5V supply.  
 Note 4: The offset voltages and these parameters define an error.  
 Note 5: The response time specified.  
 Note 6: Output is pulled up to 1V.  
 Note 7: Refer to RETS119X for

LM119A/LM119/LM219/LM319A/LM319

### Absolute Maximum Ratings LM119A/119/219

If Military/Aerospace specified devices are required, please contact the National Semiconductor Sales Office/Distributors for availability and specifications. (Note 7)

Total Supply Voltage	36V
Output to Negative Supply Voltage	36V
Ground to Negative Supply Voltage	25V
Ground to Positive Supply Voltage	18V
Differential Input Voltage	±5V
Input Voltage (Note 1)	±15V
ESD rating (1.5 kΩ in series with 100 pF)	800V
Power Dissipation (Note 2)	500 mW
Output Short Circuit Duration	10 sec

Operating Temperature Range	
LM119A, LM119	-55°C to 125°C
LM219	-25°C to 85°C
Storage Temperature Range	-65°C to 150°C
Lead Temperature (Soldering, 10 sec.)	260°C
Soldering Information	
Dual-In-Line Package	
Soldering (10 seconds)	260°C
Small Outline Package	
Vapor Phase (60 seconds)	215°C
Infrared (15 seconds)	220°C

See AN-450 "Surface Mounting Methods and Their Effect on Product Reliability" for other methods of soldering surface mount devices.

### Electrical Characteristics (Note 3)

Parameter	Conditions	LM119A			LM119/LM219			Units
		Min	Typ	Max	Min	Typ	Max	
Input Offset Voltage (Note 4)	$T_A = 25^\circ\text{C}, R_S \leq 5\text{k}$		0.5	1.0		0.7	4.0	mV
Input Offset Current (Note 4)	$T_A = 25^\circ\text{C}$		20	40		30	75	nA
Input Bias Current	$T_A = 25^\circ\text{C}$		150	500		150	500	nA
Voltage Gain	$T_A = 25^\circ\text{C}$ (Note 6)	20	40		10	40		V/mV
Response Time (Note 5)	$T_A = 25^\circ\text{C}, V_S = \pm 15\text{V}$		80			80		ns
Saturation Voltage	$V_{IN} \leq -5\text{ mV}, I_{OUT} = 25\text{ mA}$ $T_A = 25^\circ\text{C}$		0.75	1.5		0.75	1.5	V
Output Leakage Current	$V_{IN} \geq 5\text{ mV}, V_{OUT} = 35\text{V}$ $T_A = 25^\circ\text{C}$		0.2	2		0.2	2	μA
Input Offset Voltage (Note 4)	$R_S \leq 5\text{k}$		1.2	2.0			7	mV
Input Offset Current (Note 4)				75			100	nA
Input Bias Current				1000			1000	nA
Input Voltage Range	$V_S = \pm 15\text{V}$ $V^+ = 5\text{V}, V^- = 0$	-12 1	±13	+12 3	-12 1	±13	+12 3	V V
Saturation Voltage	$V^+ \geq 4.5\text{V}, V^- = 0$ $V_{IN} \leq -6\text{ mV}, I_{SINK} \leq 3.2\text{ mA}$ $T_A \geq 0^\circ\text{C}$ $T_A \leq 0^\circ\text{C}$		0.23	0.4 0.6		0.23	0.4 0.6	V V
Output Leakage Current	$V_{IN} \geq 5\text{ mV}, V_{OUT} = 35\text{V},$ $V^- = V_{GND} = 0\text{V}$		1	10		1	10	μA
Differential Input Voltage				±5			±5	V
Positive Supply Current	$T_A = 25^\circ\text{C}, V^+ = 5\text{V}, V^- = 0$		4.3			4.3		mA
Positive Supply Current	$T_A = 25^\circ\text{C}, V_S = \pm 15\text{V}$		8	11.5		8	11.5	mA
Negative Supply Current	$T_A = 25^\circ\text{C}, V_S = \pm 15\text{V}$		3	4.5		3	4.5	mA

Note 1: For supply voltages less than ±15V the absolute maximum input voltage is equal to the supply voltage.

Note 2: The maximum junction temperature of the LM119A and LM119 is 150°C, while that of the LM219 is 110°C. For operating at elevated temperatures, devices in the H10 package must be derated based on a thermal resistance of 160°C/W, junction to ambient, or 19°C/W, junction to case. The thermal resistance of the J14 package is 100°C/W, junction to ambient.

Note 3: These specifications apply for  $V_S = \pm 15\text{V}$ , and the Ground pin at ground, and  $-55^\circ\text{C} \leq T_A \leq +125^\circ\text{C}$ , unless otherwise stated. With the LM219, however, all temperature specifications are limited to  $-25^\circ\text{C} \leq T_A \leq +85^\circ\text{C}$ . The offset voltage, offset current and bias current specifications apply for any supply voltage from a single 5V supply up to ±15V supplies. Do not operate the device with more than 16V from ground to  $V_S$ .

Note 4: The offset voltages and offset currents given are the maximum values required to drive the output within a volt of either supply with a 1 mA load. Thus, these parameters define an error band and take into account the worst case effects of voltage gain and input impedance.

Note 5: The response time specified (see definitions) is for a 100 mV input step with 5 mV overdrive.

Note 6: Output is pulled up to 15V through a 1.4 kΩ resistor.

Note 7: Refer to RETS119X for LM119H/883 and LM119J/883 specifications, RETS119AX for LM119AH/883 and LM119AJ/883 specifications.

5

## Absolute Maximum Ratings LM319A/319

If Military/Aerospace specified devices are required, please contact the National Semiconductor Sales Office/Distributors for availability and specifications.

Total Supply Voltage	36V
Output to Negative Supply Voltage	36V
Ground to Negative Supply Voltage	25V
Ground to Positive Supply Voltage	18V
Differential Input Voltage	±5V
Input Voltage (Note 1)	±15V
Power Dissipation (Note 2)	500 mW
Output Short Circuit Duration	10 sec
ESD rating (1.5 kΩ in series with 100 pF)	800V

Operating Temperature Range LM319A, LM319	0°C to 70°C
Storage Temperature Range	-65°C to 150°C
Lead Temperature (Soldering, 10 sec.)	260°C
Soldering Information	
Dual-In-Line Package	
Soldering (10 sec.)	260°C
Small Outline Package	
Vapor Phase (60 sec.)	215°C
Infrared (15 sec.)	220°C

See AN-450 "Surface Mounting Methods and Their Effect on Product Reliability" for other methods of soldering surface mount devices.

## Electrical Characteristics (Note 3)

Parameter	Conditions	LM319A			LM319			Units
		Min	Typ	Max	Min	Typ	Max	
Input Offset Voltage (Note 4)	$T_A = 25^\circ\text{C}$ , $R_S \leq 5\text{k}$		0.5	1.0		2.0	8.0	mV
Input Offset Current (Note 4)	$T_A = 25^\circ\text{C}$		20	40		80	200	nA
Input Bias Current	$T_A = 25^\circ\text{C}$		150	500		250	1000	nA
Voltage Gain	$T_A = 25^\circ\text{C}$ (Note 6)	20	40		8	40		V/mV
Response Time (Note 5)	$T_A = 25^\circ\text{C}$ , $V_S = \pm 15\text{V}$		80			80		ns
Saturation Voltage	$V_{IN} \leq -10\text{ mV}$ , $I_{OUT} = 25\text{ mA}$ $T_A = 25^\circ\text{C}$		0.75	1.5		0.75	1.5	V
Output Leakage Current	$V_{IN} \geq 10\text{ mV}$ , $V_{OUT} = 35\text{V}$ , $V^- = V_{GND} = 0\text{V}$ , $T_A = 25^\circ\text{C}$		0.2	10		0.2	10	μA
Input Offset Voltage (Note 4)	$R_S \leq 5\text{k}$			10			10	mV
Input Offset Current (Note 4)				300			300	nA
Input Bias Current				1000			1200	nA
Input Voltage Range	$V_S = \pm 15\text{V}$ $V^+ = 5\text{V}$ , $V^- = 0$	1	±13		1	±13		V
Saturation Voltage	$V^+ \geq 4.5\text{V}$ , $V^- = 0$ $V_{IN} \leq -10\text{ mV}$ , $I_{SINK} \leq 3.2\text{ mA}$		0.3	0.4		0.3	0.4	V
Differential Input Voltage				±5			±5	V
Positive Supply Current	$T_A = 25^\circ\text{C}$ , $V^+ = 5\text{V}$ , $V^- = 0$		4.3			4.3		mA
Positive Supply Current	$T_A = 25^\circ\text{C}$ , $V_S = \pm 15\text{V}$		8	12.5		8	12.5	mA
Negative Supply Current	$T_A = 25^\circ\text{C}$ , $V_S = \pm 15\text{V}$		3	5		3	5	mA

Note 1: For supply voltages less than ±15 the absolute maximum input voltage is equal to the supply voltage.

Note 2: The maximum junction temperature of the LM319A and LM319 is 85°C. For operating at elevated temperatures, devices in the H10 package must be derated based on a thermal resistance of 160°C/W, junction to ambient, or 19°C/W, junction to case. The thermal resistance of the N14 and J14 package is 100°C/W, junction to ambient. The thermal resistance of the M14 package is 115°C/W, junction to ambient.

Note 3: These specifications apply for  $V_S = \pm 15\text{V}$ , and  $0^\circ\text{C} \leq T_A \leq 70^\circ\text{C}$ , unless otherwise stated. The offset voltage, offset current and bias current specifications apply for any supply voltage from a single 5V supply up to ±15V supplies. Do not operate the device with more than 16V from ground to  $V_S$ .

Note 4: The offset voltages and offset currents given are the maximum values required to drive the output within a volt of either supply with a 1 mA load. Thus, these parameters define an error band and take into account the worst case effects of voltage gain and input impedance.

Note 5: The response time specified is for a 100 mV input step with 5 mV overdrive.

Note 6: Output is pulled up to 15V through a 1.4 kΩ resistor.

## Typical Performance

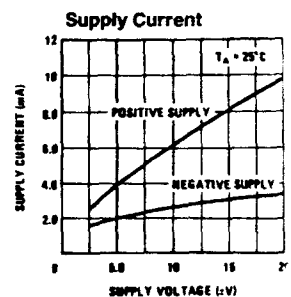
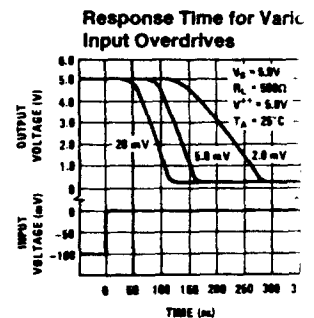
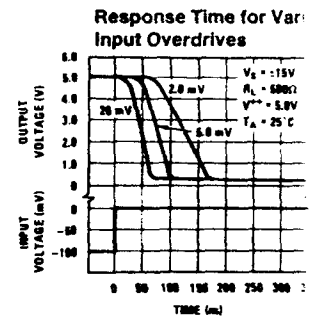
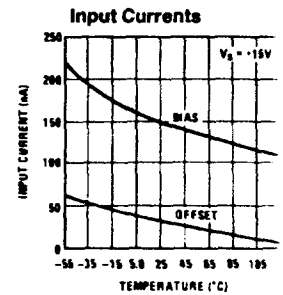

# Typical Performance Characteristics LM119A/LM119/LM219

LM119A/LM119/LM219/LM319A/LM319

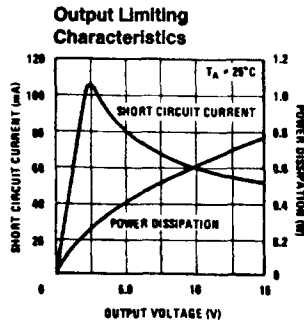
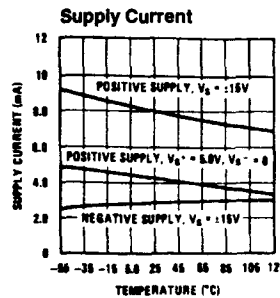
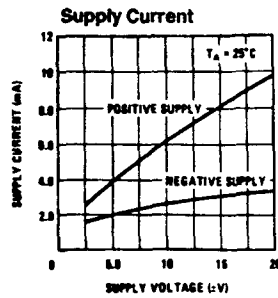
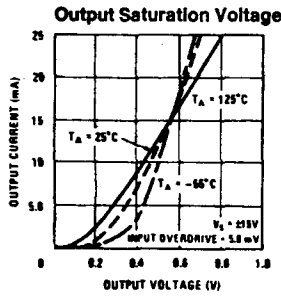
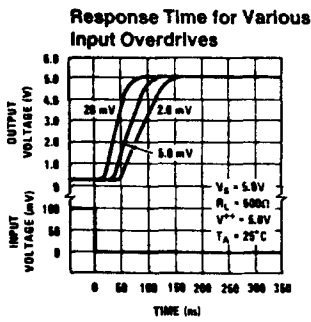
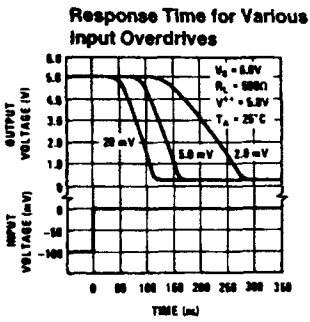
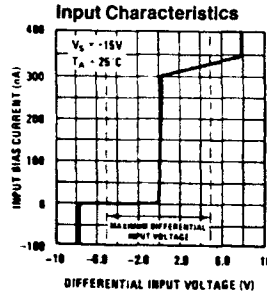
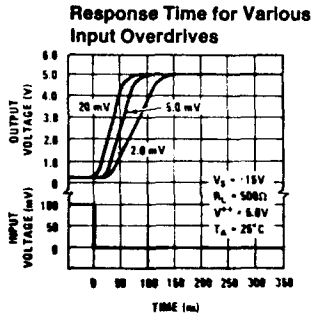
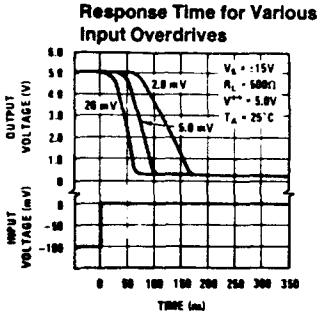
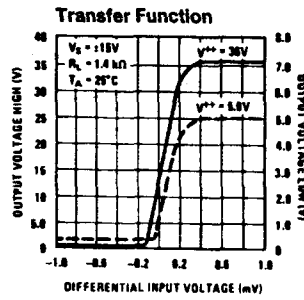
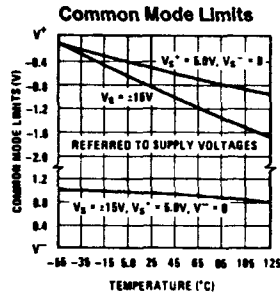
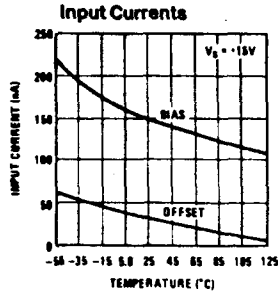

TL/H/5705-2

Typical Performance Characteristics LM319A, LM319

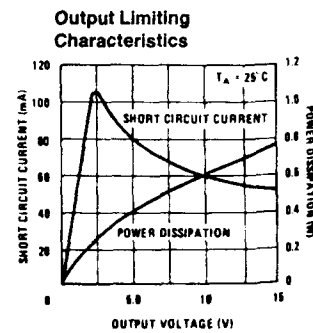
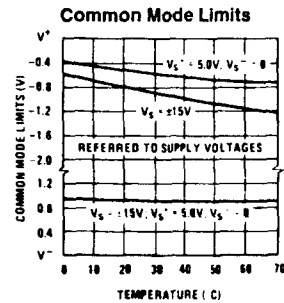
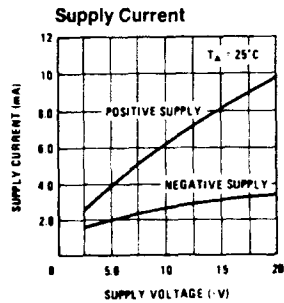
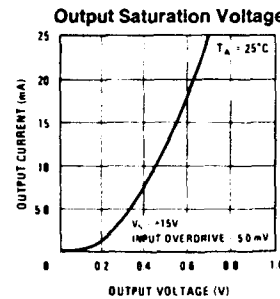
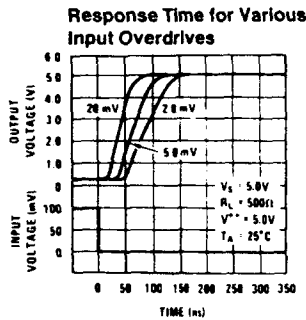
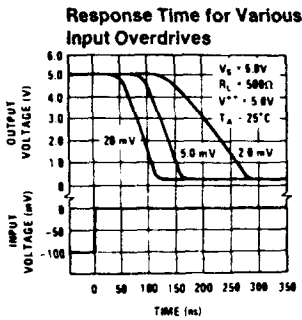
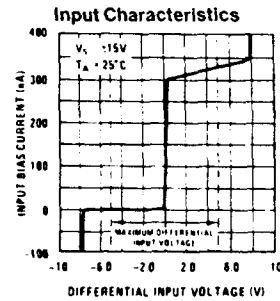
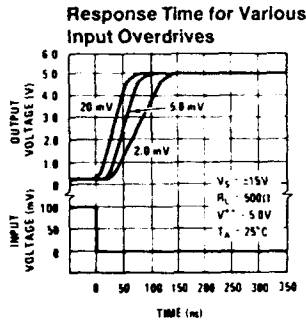
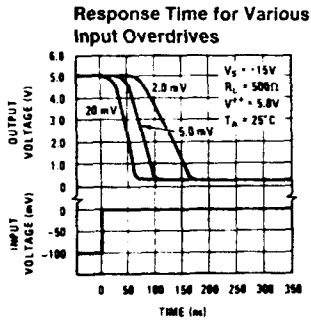
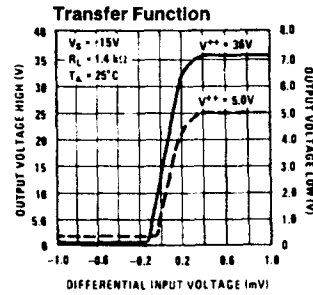
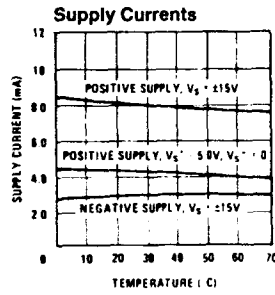
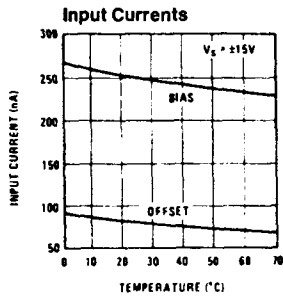

TL/H/5705-3

Schematic Diagram

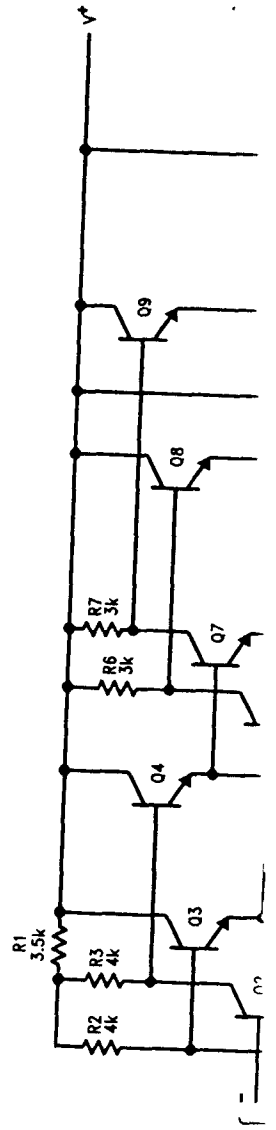

# Schematic Diagram

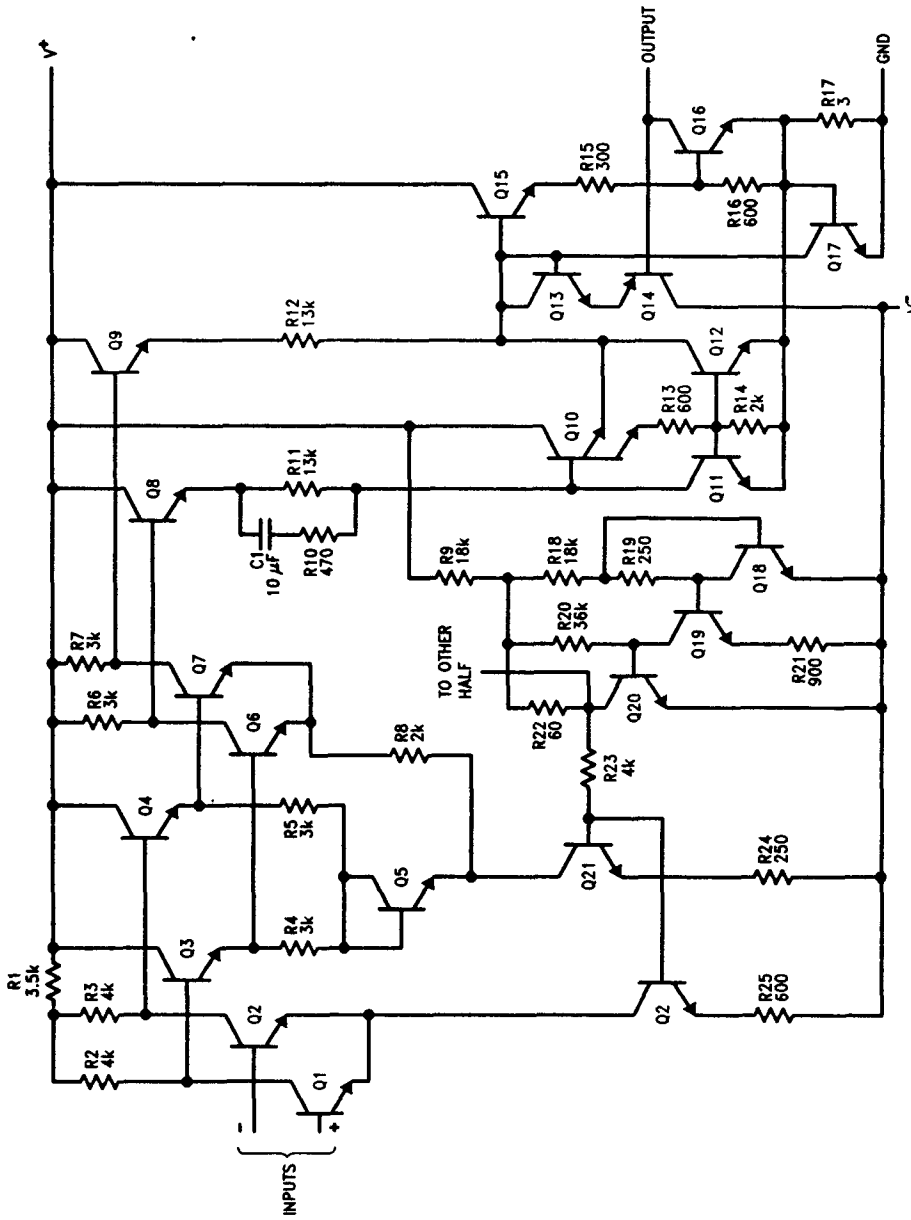

\*Do not operate the LM118 with more than 18V between GND and  $V^+$

TL/H/5705-1

LM119A/LM119/LM219/LM319A/LM319

5