



Precision Monolithics Inc.

# SW-201/SW-202

## QUAD SPST JFET ANALOG SWITCHES



**ABSOLUTE MAXIMUM RATINGS**

Operating Temperature Range	SW-201GP, GS, SW202GP, GS
Junction Temperature (T <sub>J</sub> )	.....
Storage Temperature Range	.....
P-Suffix	.....
Lead Temperature (Soldering, 60°C)	.....
Maximum Junction Temperature	.....
V <sub>+</sub> Supply to V <sub>-</sub> Supply	.....
V <sub>+</sub> Supply to Ground	.....
Logic Input Voltage	.....
Analog Input Voltage Range	.....
Continuous	.....

### FEATURES

#### SW-201

- Normally "ON" for Logic 0 Input
- Improved Performance and Pin Compatible With DG-201, LF11201/13201, IH201, and IH201

#### SW-202

- Normally "OFF" For Logic 0 Input
- Improved Performance and Pin Compatible With LF11202/12202/13202 and IH202

#### Both SW-201 and SW-202

- Highly Resistant to Static Discharge Destruction
- Guaranteed Break-Before-Make Switching ( $t_{OFF} < t_{ON}$ )
- Low "ON" Resistance ..... 80Ω Max
- Guaranteed R<sub>ON</sub> Matching ..... 15% Max
- Low R<sub>ON</sub> Variation from Analog Input Voltage ..... 5%
- High Analog Current Operation ..... 10mA Min
- Low Leakage Currents at High Temperatures:
  - T<sub>A</sub> = 125°C ..... 60nA Max
  - T<sub>A</sub> = 85°C ..... 30nA Max
- Guaranteed Switching Speeds:
  - t<sub>ON</sub> = 500ns Max t<sub>OFF</sub> = 400ns Max
- Digital Inputs are TTL and CMOS Compatible
- Dual or Single Supply Operation
- Available in Die Form

### GENERAL DESCRIPTION

The SW-201 and SW-202 each consist of four independent, single-pole, single-throw (SPST) analog switches, which may be independently digitally controlled. Each SW-201 switch is normally closed (NC), whereas each SW-202 is normally open (NO) when the corresponding digital control input is a zero. The SW-201 and SW-202 are otherwise identical.

The judicious combination of bipolar and FET devices in a single monolithic IC results in a product with performance characteristics and ruggedness that are superior to those of a similar circuit fabricated using CMOS technology.

Increased reliability is complemented by excellent electrical specifications. Potential error sources are reduced by minimizing "ON" resistance and controlling leakage currents at high temperatures. The switching FET exhibits minimal R<sub>ON</sub> variation over a 20V analog signal range and with power supply voltage changes. Operation from a single positive power supply voltage is possible. With V<sub>+</sub> = 36V, V<sub>-</sub> = 0V, the analog signal range will extend from ground to +32V.

The PNP logic inputs are TTL and CMOS compatible. Logic input currents are at micro-ampere levels which improves circuit fan in.

### PIN CONNECTIONS

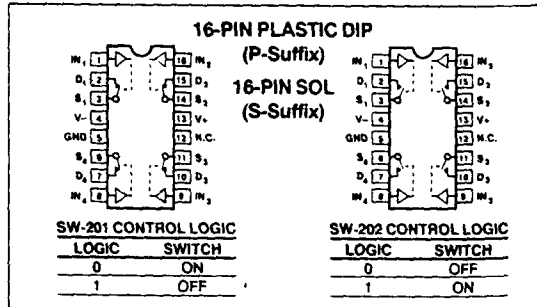

### ORDERING INFORMATION

PACKAGE	SWITCH CONFIGURATION		OPERATING TEMPERATURE RANGE
	NC	NO	
16-PIN EPOXY	SW201GP	SW202GP	XIND
16-PIN SOL	SW201GS	SW202GS	XIND

† Burn-in is available on commercial and industrial temperature range parts in CerDIP, plastic DIP, and TO-can packages. For ordering information, see 1990/91 Data Book, Section 2.

### SIMPLIFIED SCHEMATIC DIAGRAM (ONE SWITCH)

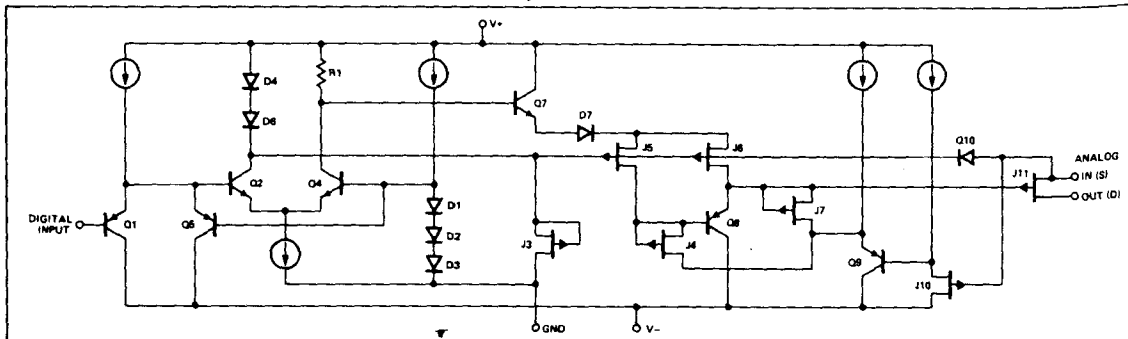

Manufactured under the following patent: 4,228,367

### ELECTRICAL CHARACTERISTICS

PARAMETER	SYMBOL
"ON" Resistance	R <sub>ON</sub>
R <sub>ON</sub> Match Between Switches	R <sub>ON</sub> Mat.
Analog Voltage Range	V <sub>A</sub>
Analog Current Range	I <sub>A</sub>
ΔR <sub>ON</sub> vs Applied Voltage	ΔR <sub>ON</sub>
Source Current in "OFF" Condition	I <sub>S</sub> OFF
Drain Current in "OFF" Condition	I <sub>D</sub> OFF
Leakage Current in "ON" Condition	I <sub>S</sub> ON + I <sub>D</sub> ON
Logical "1" Input Current	I <sub>INH</sub>
Logical "0" Input Current	I <sub>INL</sub>
Turn-On-Time	t <sub>ON</sub>
Turn-Off-Time	t <sub>OFF</sub>
Break-Before-Make Time	t <sub>ON</sub> -t <sub>OFF</sub>
Source Capacitance	C <sub>S</sub> OFF
Drain Capacitance	C <sub>D</sub> OFF
Channel "ON" Capacitance	C <sub>D</sub> ON + C <sub>S</sub> ON
"OFF" Isolation	I <sub>SO</sub> OFF
Crosstalk	C <sub>T</sub>
Positive Supply Current	I <sub>+</sub>
Negative Supply Current	I <sub>-</sub>
Positive Supply Current	I <sub>+</sub>
Negative Supply Current	I <sub>-</sub>
Ground Current	I <sub>G</sub>

**ABSOLUTE MAXIMUM RATINGS (Note 1)**

Operating Temperature Range	SW-201GP, GS, SW202GP, GS	-40°C to +85°C
Junction Temperature (T <sub>J</sub> )		-65°C to +150°C
Storage Temperature Range		-65°C to +150°C
P-Suffix		-65°C to +125°C
Lead Temperature (Soldering, 60 sec)		+300°C
Maximum Junction Temperature		+150°C
V+ Supply to V- Supply		36V
V+ Supply to Ground		36V
Logic Input Voltage		(-4V or V-) to V+ Supply
Analog Input Voltage Range	Continuous	V- Supply to V+ Supply + 20V

1% Duty Cycle and Driving All 4 Inputs with  
500µsec Pulse ..... V- Supply -15V to V+ Supply + 20V  
Maximum Current Through Any Pin ..... 30mA

PACKAGE TYPE	θ <sub>JA</sub> (Note 2)	θ <sub>JC</sub>	UNITS
16-Pin Plastic DIP (P)	82	39	°C/W
16-Pin SOL (S)	98	30	°C/W

**NOTES:**

1. Absolute ratings apply to both DICE and packaged parts, unless otherwise noted.
2. θ<sub>JA</sub> is specified for worst case mounting conditions, i.e., θ<sub>JA</sub> is specified for device in socket for P-DIP package; θ<sub>JA</sub> is specified for device soldered to printed circuit board for SOL package.

**ELECTRICAL CHARACTERISTICS at V<sub>±</sub> = ±15V and T<sub>A</sub> = 25°C, unless otherwise noted.**

PARAMETER	SYMBOL	CONDITIONS	SW-201G SW-202G			UNITS
			MIN	TYP	MAX	
"ON" Resistance	R <sub>ON</sub>	V <sub>A</sub> = 0V, I <sub>S</sub> = 1mA V <sub>A</sub> = ±10V, I <sub>S</sub> = 1mA	—	100	150	Ω
R <sub>ON</sub> Match Between Switches	R <sub>ON</sub> Match	V <sub>A</sub> = 0V, I <sub>D</sub> = 100µA, Note 1	—	—	20	%
Analog Voltage Range	V <sub>A</sub>	I <sub>S</sub> = 1.0mA, Note 6 I <sub>S</sub> = 1.0mA	+10 -10	+11 -15	—	V
Analog Current Range	I <sub>A</sub>	V <sub>S</sub> = ±10V	5	10	—	mA
ΔR <sub>ON</sub> vs Applied Voltage	ΔR <sub>ON</sub>	V <sub>S</sub> ≤ 10V, I <sub>S</sub> = 1mA	—	10	20	%
Source Current in "OFF" Condition	I <sub>S(OFF)</sub>	V <sub>S</sub> = 10V, V <sub>D</sub> = -10V, Note 5	—	—	10	nA
Drain Current in "OFF" Condition	I <sub>D(OFF)</sub>	V <sub>S</sub> = 10V, V <sub>D</sub> = -10V, Note 5	—	—	10	nA
Leakage Current in "ON" Condition	I <sub>S(ON)</sub> + I <sub>D(ON)</sub>	V <sub>S</sub> = V <sub>D</sub> = ±10V, Note 5	—	—	10	nA
Logical "1" Input Current	I <sub>INH</sub>	V <sub>IN</sub> = 2V to 15V, Note 4	—	—	10	µA
Logical "0" Input Current	I <sub>INL</sub>	V <sub>IN</sub> = 0.8	—	1.5	10.0	µA
Turn-On-Time	t <sub>ON</sub>	See Switching Time Test Circuit, Note 7	—	340	700	ns
Turn-Off-Time	t <sub>OFF</sub>	See Switching Time Test Circuit, Note 7	—	200	500	ns
Break-Before-Make Time	t <sub>ON-tOFF</sub>	Note 3	50	140	—	ns
Source Capacitance	C <sub>S(OFF)</sub>	V <sub>A</sub> = 0V, Note 5	—	7	—	pF
Drain Capacitance	C <sub>D(OFF)</sub>	V <sub>A</sub> = 0V, Note 5	—	5.5	—	pF
Channel "ON" Capacitance	C <sub>D(ON)</sub> + C <sub>S(ON)</sub>	V <sub>S</sub> = V <sub>D</sub> = 0V, Note 5	—	15	—	pF
"OFF" Isolation	I <sub>SO(OFF)</sub>	V <sub>S</sub> = 5V <sub>RMS</sub> , R <sub>L</sub> = 680Ω, C <sub>L</sub> = 7pF, f = 500kHz, Note 5	—	58	—	dB
Crosstalk	C <sub>T</sub>	V <sub>S</sub> = 5V <sub>RMS</sub> , R <sub>L</sub> = 680Ω, C <sub>L</sub> = 7pF, f = 500kHz, Note 5	—	70	—	dB
Positive Supply Current	I <sub>+</sub>	All Channels "ON", Note 5	—	4	12	mA
Negative Supply Current	I <sub>-</sub>	All Channels "ON", Note 5	—	1	6.5	mA
Positive Supply Current	I <sub>+</sub>	All Channels "OFF", Note 5	—	6	12	mA
Negative Supply Current	I <sub>-</sub>	All Channels "OFF", Note 5	—	4	8	mA
Ground Current	I <sub>G</sub>	All Channels "ON" or "OFF"	—	3	6	mA

ANALOG SWITCHES/MULTIPLEXERS

13

ELECTRICAL CHARACTERISTICS at  $V_{\pm} = \pm 15V$ ;  $0^{\circ}C \leq T_A \leq 70^{\circ}C$ , unless otherwise noted.

PARAMETER	SYMBOL	CONDITIONS	SW-201G SW-202G			UNITS
			MIN	TYP	MAX	
Temperature Range	$T_A$	Operating	0	—	70	$^{\circ}C$
"ON" Resistance	$R_{ON}$	$V_A = 0V, I_D = 1mA$ $V_A = \pm 10V, I_D = 1mA$	—	—	175	$\Omega$
$R_{ON}$ Match Between Switches	$R_{ON}$ Match	$V_A = 0V, I_D = 100\mu A$ ; (Note 1)	—	10	—	%
Analog Voltage Range	$V_A$	$I_S = 1.0mA$ Note 6. $I_G = 1.0mA$	+10 -10	+11 -15	—	V
Analog Current Range	$I_A$	$V_S = \pm 10V$	—	11	—	mA
$\Delta R_{ON}$ With Applied Voltage	$\Delta R_{ON}$	$V_S \leq +10V$ $I_G = 1mA$	—	15	—	%
Source Current in "OFF" Condition	$I_{S(OFF)}$	$V_S = 10V, V_D = -10V$ . Note 5. $T_A = \text{Max. Operating Temp}$	—	—	60	nA
Drain Current in "OFF" Condition	$I_{D(OFF)}$	$V_S = 10V, V_D = -10V$ . Note 5. $T_A = \text{Max. Operating Temp}$	—	—	60	nA
Leakage Current in "ON" Condition	$I_{S(ON)}$ + $I_{D(ON)}$	$V_S = V_D = \pm 10V$ . Note 5. $T_A = \text{Max. Operating Temp}$	—	—	60	nA
Logical "1" Input Voltage	$V_{INH}$	(Note 6)	2	—	—	V
Logic "0" Input Voltage	$V_{INL}$	(Note 6)	—	—	0.8	V
Logical "1" Input Current	$I_{INH}$	$V_{IN} = 2V \text{ to } 15V$ . Note 4.	—	—	15	$\mu A$
Logical "0" Input Current	$I_{INL}$	$V_{IN} = 0.8$	—	5	15	$\mu A$
Turn-On-Time	$t_{ON}$	See Switching Test Circuit. (Note 2)	—	—	1000	ns
Turn-Off-Time	$t_{OFF}$	See Switching Test Circuit. (Note 2)	—	—	500	ns
Break-Before-Make Time	$t_{ON-t_{OFF}}$	(Note 3)	—	50	—	ns
Positive Supply Current	$I_+$	All Channels "ON". (Note 5)	—	—	15.8	mA
Negative Supply Current	$I_-$	All Channels "ON". (Note 5)	—	—	14.5	mA
Positive Supply Current	$I_+$	All Channels "OFF". (Note 5)	—	—	18	mA
Negative Supply Current	$I_-$	All Channels "OFF". (Note 5)	—	—	14.5	mA
Ground Current	$I_G$	All Channels "ON" or "OFF"	—	—	10.0	mA

NOTES:

- $V_A = 0V, I_D = 100\mu A$ . Specified as a percentage of  $R_{AVERAGE}$  where:  

$$R_{AVERAGE} = \frac{R_{ON1} + R_{ON2} + R_{ON3} + R_{ON4}}{4}$$
- Guaranteed by design.
- Switch is guaranteed by design to provide break-before-make operation.
- Current tested at  $V_{IN} = 2V$ . This is worst case condition.
- Switch being tested ON or OFF as indicated,  $V_{INH} = 2V$  or  $V_{INL} = 0.8V$ , per logic truth table.
- Guaranteed by  $R_{ON}$  and leakage tests. For normal operation analog signal voltages should be restricted to less than  $(V_{+} - 4V)$ .
- Sample tested.

DICE CHARACTERISTIC

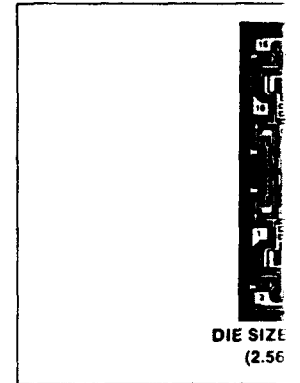

WAFER TEST LIMITS at

PARAMETER	MIN	TYP	MAX
"ON" Resistance	—	—	175
$R_{ON}$ Mismatch	—	10	—
$\Delta R_{ON}$ vs $V_A$	—	15	—
Positive Supply	—	—	15.8
Negative Supply Current	—	—	14.5
Ground Current	—	—	10.0
Analog Voltage Range	+10	+11	—
Logic "1" Input Voltage	2	—	—
Logic "0" Input Voltage	—	—	0.8
Logic "0" Input Current	—	—	15
Logic "1" Input Current	—	5	15
Analog Current Range	—	11	—

NOTE:  
Electrical tests are performed at wafer level and are not guaranteed for standard product dice.

TYPICAL ELECTRICAL CHARACTERISTICS

PARAMETER	MIN	TYP	MAX
"ON" Resistance	—	—	175
Turn-On-Time	—	—	1000
Turn-Off-Time	—	—	500
Drain Current in "OFF" Condition	—	—	60
"OFF" Isolation	—	—	60
Crosstalk	—	—	—

- NOTES:
- Power supply and ground current.
  - Current tested at  $V_{IN} = 2V$ . This is worst case condition.
  - Guaranteed by  $R_{ON}$  and leakage tests.

DICE CHARACTERISTICS

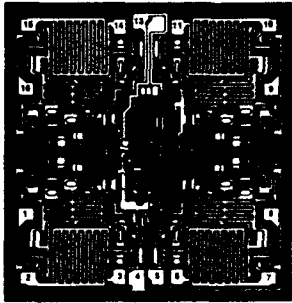

- 1. IN1
- 2. D1
- 3. S1
- 4. V- (SUBSTRATE)
- 5. GND
- 6. S2
- 7. D2
- 8. IN2
- 9. IN3
- 10. D3
- 11. S3
- 13. V+
- 14. S4
- 15. D4
- 16. IN4

For additional DICE ordering information, refer to PMI's Data Book, Section 2.

DIE SIZE 0.101 x 0.097 inch, 9797 sq. mils  
(2.565 x 2.464 mm, 6.320 sq. mm)

WAFER TEST LIMITS at  $V_+ = 15V$ ,  $V_- = -15V$ ,  $T_A = 25^\circ C$ , unless otherwise noted.

PARAMETER	SYMBOL	CONDITIONS	SW-201N SW-202N LIMIT	SW-201G SW-202G LIMIT	UNITS
"ON" Resistance	$R_{ON}$	$-10V \leq V_A \leq 10V, I_S \leq 1mA$	80	100	$\Omega$ MAX
$R_{ON}$ Mismatch	$R_{ON}$ Match	$V_A = 0V, I_S \leq 100\mu A$	15	20	% MAX
$\Delta R_{ON}$ vs $V_A$	$\Delta R_{ON}$	$V_S \leq 10V, I_S = 1mA$	15	20	% MAX
Positive Supply	I+	(Note 1)	9	10.5	mA MAX
Negative Supply Current	I-	(Note 1)	6	7	mA MAX
Ground Current	$I_G$		4	4	mA MAX
Analog Voltage Range	$V_A$	$I_S = 1mA$ (Note 3)	$\pm 10$	$\pm 10$	V MIN
Logic "1" Input Voltage	$V_{INH}$	(Note 3)	2	2	V MIN
Logic "0" Input Voltage	$V_{INL}$	(Note 3)	0.8	0.8	V MAX
Logic "0" Input Current	$I_{INL}$	$0V \leq V_{IN} \leq 0.8V$	5	5	$\mu A$ MAX
Logic "1" Input Current	$I_{INH}$	$2V \leq V_{IN} \leq 15V$ , (Note 2)	5	5	$\mu A$ MAX
Analog Current Range	$I_A$	$V_S = \pm 10V$	10	7	mA MIN

NOTE:

Electrical tests are performed at wafer probe to the limits shown. Due to variations in assembly methods and normal yield loss, yield after packaging is not guaranteed for standard product dice. Consult factory to negotiate specifications based on dice lot qualification through sample lot assembly and testing.

TYPICAL ELECTRICAL CHARACTERISTICS  $V_+ = 15V$ ,  $V_- = -15V$  and  $T_A = 25^\circ C$ , unless otherwise noted.

PARAMETER	SYMBOL	CONDITIONS	SW-201N SW-202N TYPICAL	SW-201G SW-202G TYPICAL	UNITS
"ON" Resistance	$R_{ON}$	$-10V \leq V_A \leq 10V, I_S \leq 1mA$	80	80	$\Omega$
Turn-On-Time	$t_{ON}$		340	340	ns
Turn-Off-Time	$t_{OFF}$		200	200	ns
Drain Current in "OFF" Condition	$I_{D(OFF)}$	$V_S = 10V, V_D = -10V$	0.3	0.3	nA
"OFF" Isolation	$I_{SO(OFF)}$	$f = 500kHz, R_L = 680\Omega$	58	58	dB
Crosstalk	$C_T$	$f = 500kHz, R_L = 680\Omega$	70	70	dB

NOTES:

- Power supply and ground current specified for switch "ON" or "OFF".
- Current tested at  $V_{IN} = 2V$ . This is worst case condition.
- Guaranteed by  $R_{ON}$  and leakage tests.

ANALOG SWITCHES/MULTIPLEXERS

TYPICAL PERFORMANCE CHARACTERISTICS

"ON" RESISTANCE vs ANALOG VOLTAGE ( $V_A$ )

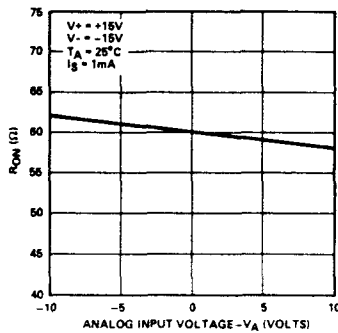

SWITCHING TIME vs TEMPERATURE

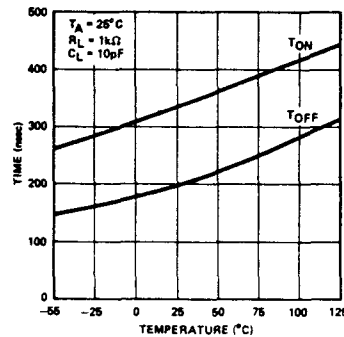

SWITCHING TIME vs ANALOG VOLTAGE

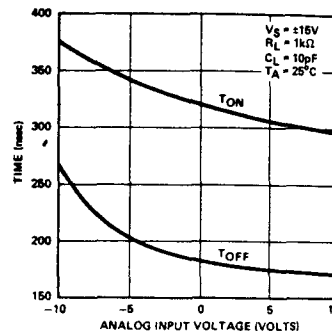

$R_{ON}$  vs TEMPERATURE

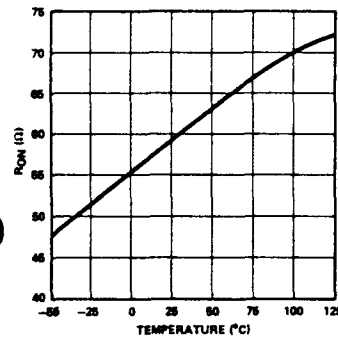

CROSSTALK AND "OFF" ISOLATION vs FREQUENCY

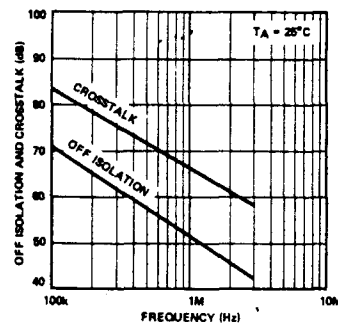

LEAKAGE CURRENT vs TEMPERATURE

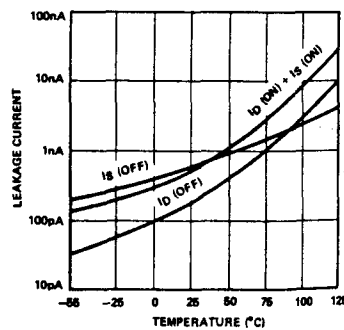

"ON" RESISTANCE vs POWER SUPPLY VOLTAGE

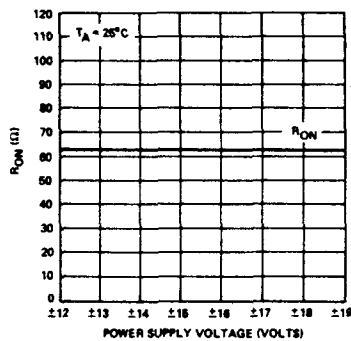

SWITCH CURRENT vs VOLTAGE

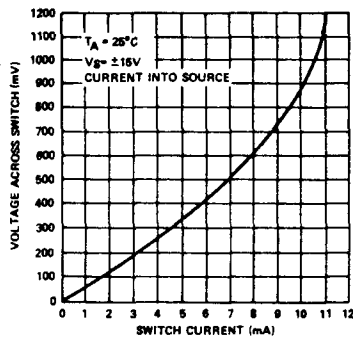

SWITCH CAPACITANCE vs ANALOG VOLTAGE

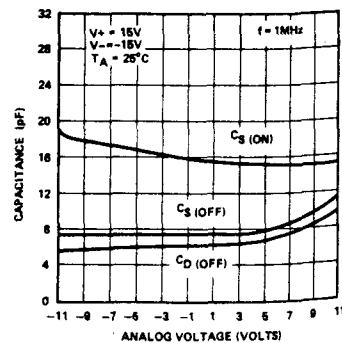

TYPICAL PERFORMANCE

$t_{ON}/t_{OFF}$  SWI

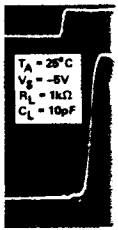

TOP TRACE: LOG  
BOTTOM TRACE:

OFF ISOLATION TEST CIRCUIT

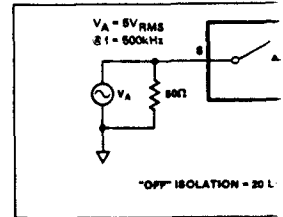

"OFF" ISOLATION = 20 L

SWITCHING TIME TEST CIRCUIT

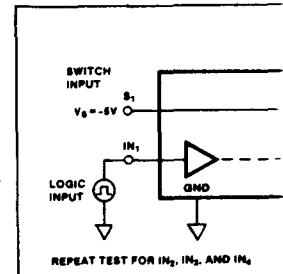

REPEAT TEST FOR  $I_{N1}$ ,  $I_{N2}$  AND  $I_{N3}$

CROSSTALK TEST CIRCUIT

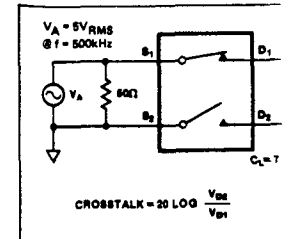

CROSSTALK = 20 LOG  $\frac{V_{D2}}{V_{D1}}$

TYPICAL PERFORMANCE CHARACTERISTICS

SW-201  
t<sub>ON</sub>/t<sub>OFF</sub> SWITCHING RESPONSE

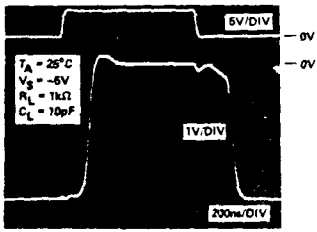

TOP TRACE: LOGIC INPUT (5V/DIV)  
BOTTOM TRACE: SWITCH OUTPUT (1V/DIV)

SW-202  
t<sub>ON</sub>/t<sub>OFF</sub> SWITCHING RESPONSE

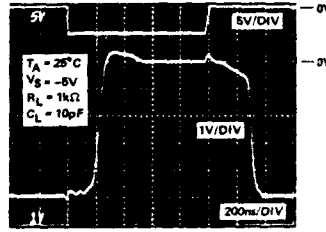

TOP TRACE: LOGIC INPUT (5V/DIV)  
BOTTOM TRACE: SWITCH OUTPUT (1V/DIV)

OFF ISOLATION TEST CIRCUIT

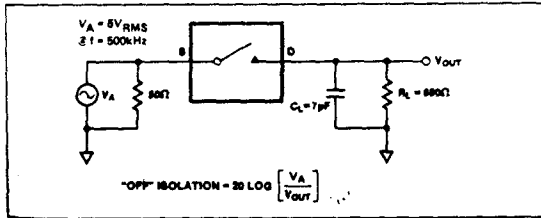

SW-201 WAVEFORMS

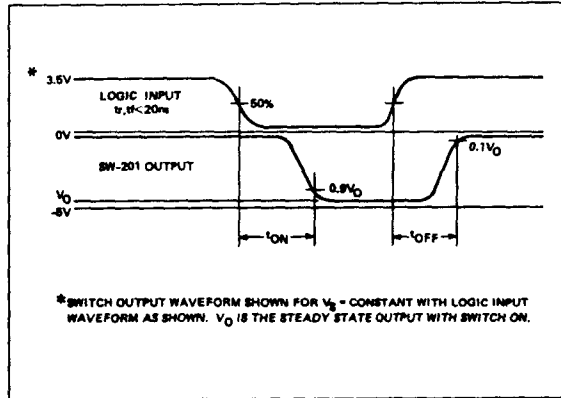

SWITCHING TIME TEST CIRCUIT

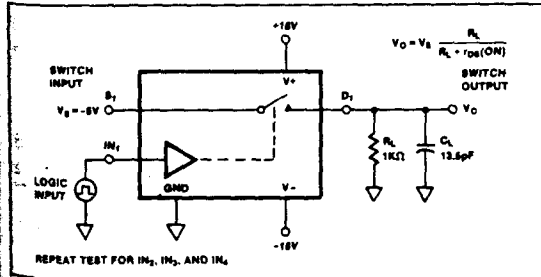

SW-202 WAVEFORMS

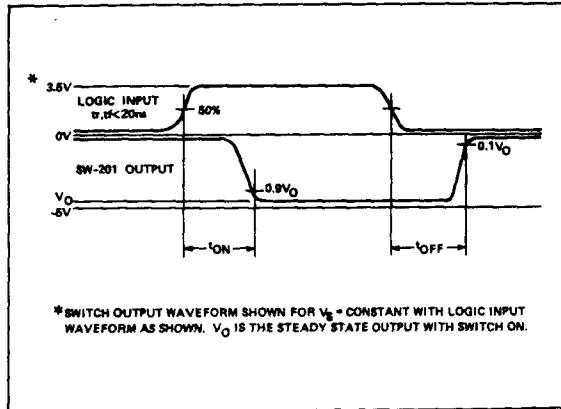

CROSSTALK TEST CIRCUIT

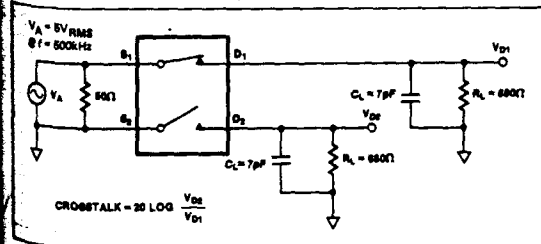

ANALOG SWITCHES/MULTIPLEXERS

**APPLICATIONS INFORMATION**

This analog switch employs ion-implanted JFETs in a switch configuration designed to assure break-before-make action. The turn-off time is much faster than the turn-on time to guarantee this feature over the full operating temperature and input voltage range. Fabricated with Bipolar-JFET processing rather than CMOS, special handling is not necessary to prevent damage to these switches. Because the digital inputs only require a 2V logic "1" input level, power-consuming pullup resistors are not required for TTL compatibility to insure break-before-make switching as is most often the case with CMOS switches. The digital inputs utilize PNP input transistors where input current is maximum at the logic "0" level and drops to that of a reverse-biased diode as the input voltage is raised above  $\approx 1.4V$ .

The "ON" resistance,  $R_{ON}$ , of the analog switches is constant over the wide input voltage range of  $-15V$  to  $+11V$  with  $V_{SUPPLY} = \pm 15V$ . For normal operation, however, positive input voltages should be restricted to  $11V$  (or  $4V$  less than the positive supply). This assures that the  $V_{GS}$  of an OFF switch remains greater than its  $V_p$ , and prevents that channel from being falsely turned ON. Individual switches are "ON" without power applied.

**TYPICAL APPLICATIONS**

**PROGRAMMABLE GAIN NONINVERTING AMPLIFIER WITH SELECTABLE INPUTS**

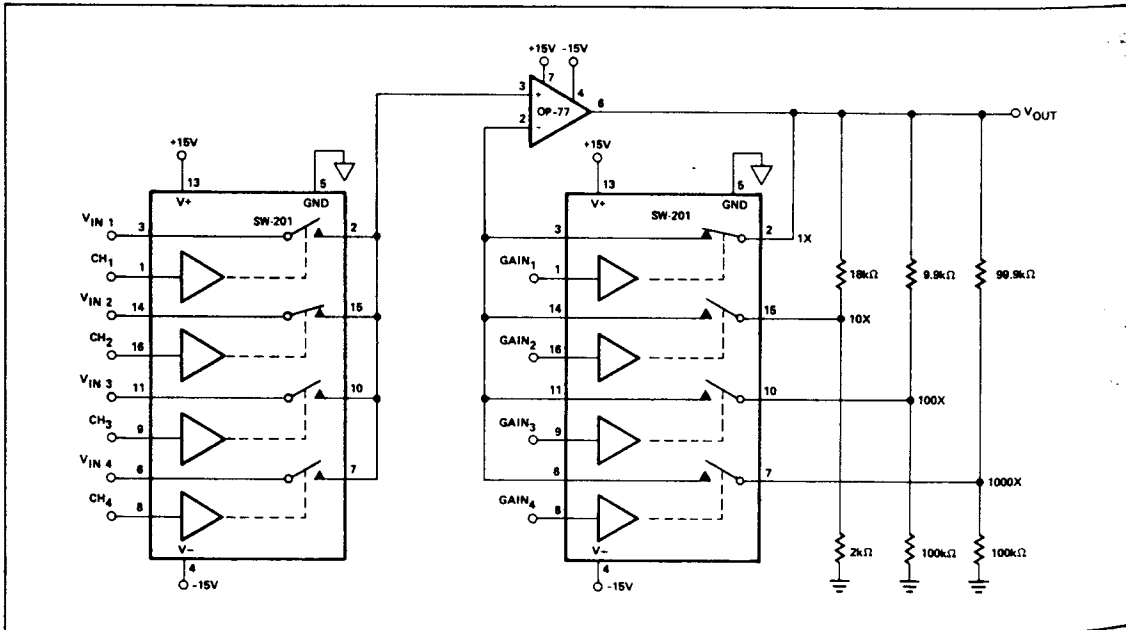

**OPERATION FROM SINGLE POSITIVE POWER SUPPLY™**

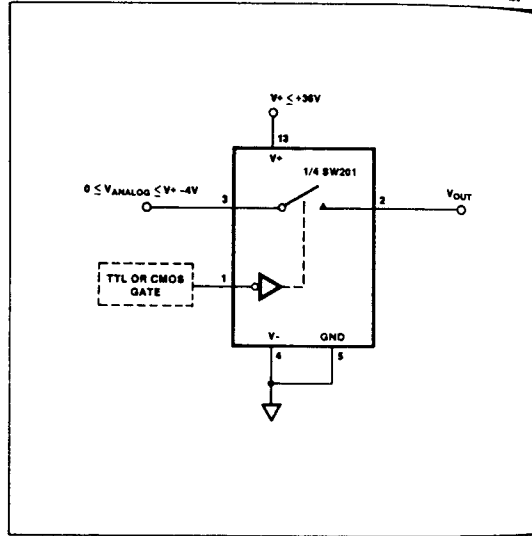

Precision Monolithics Inc.

**FEATURES**

- Wide Bandwidth .....
- Very Low  $R_{ON}$  .....
- Differential ECL Controls .....
- Fast Switching Speed .....
- 40-Pin LCC .....
- Low Insertion Loss .....
- Low Feedthrough .....
- Excellent Channel-to-Chann .....

**APPLICATIONS**

- Communications
- Radar
- Attenuators
- Track and Holds

**GENERAL INFORMATION**

The SW-400 is a high-speed quad SPST JFET analog switch technology. It is ECL compatible and can be used as a switch driver. Analog input and output bandwidth.

Each switch is bidirectional and can be used as a multiplexer or a high-speed demultiplexer. Differential ECL compatible inputs and outputs can be switched independently.

**ELECTRICAL CHARACTERISTICS**

$\pm 15V$  supply,  $\pm 85^\circ C$ .

PARAMETER	SYMBOL
ON Resistance	$R_{ON}$
Switching Time - ON	$t_{ON}$
Switching Time - OFF	$t_{OFF}$
OFF Isolation	
OFF Isolation	
Insertion Loss	
Insertion Loss	
Bandwidth	
Bandwidth	
Input Voltage Range	
Logic Input "0"	$V_{INL}$
Logic Input "1"	$V_{INH}$
Power Dissipation	

This advance product information is not intended for final data sheet.

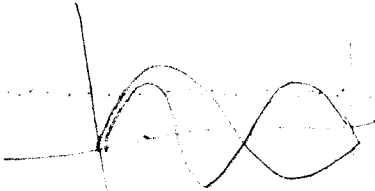
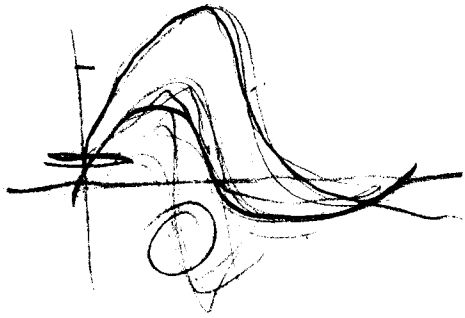

L