

Equivalent Circuit

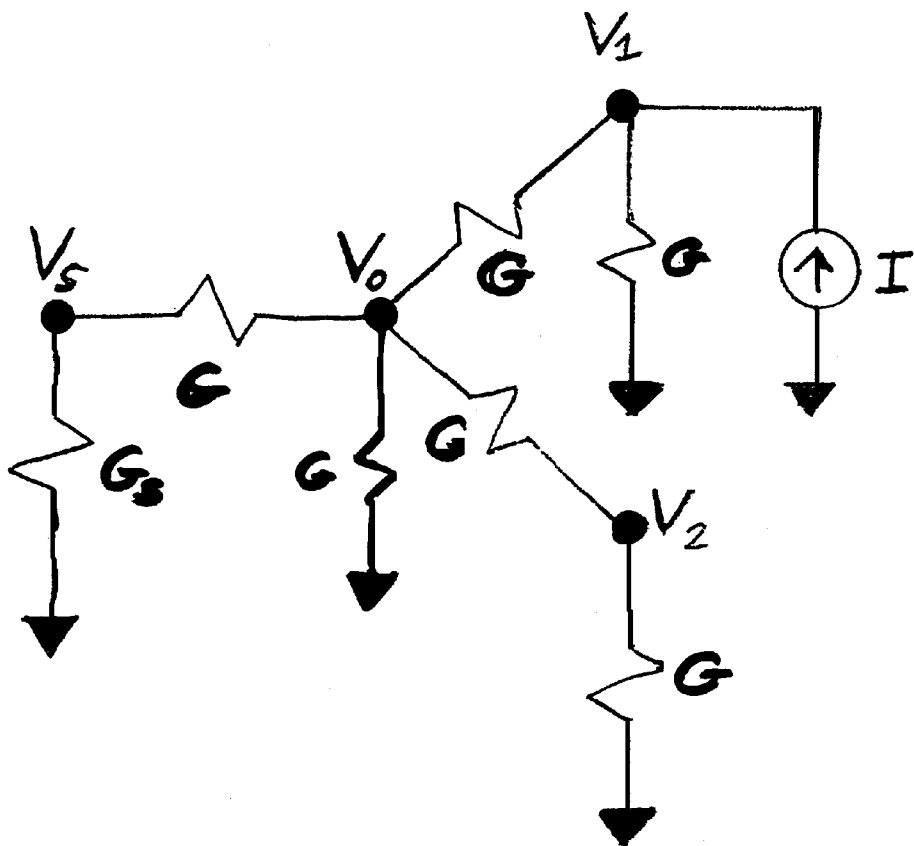

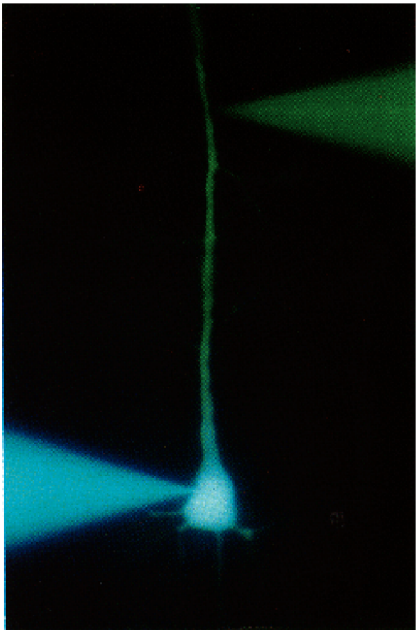

subthreshold EPSP

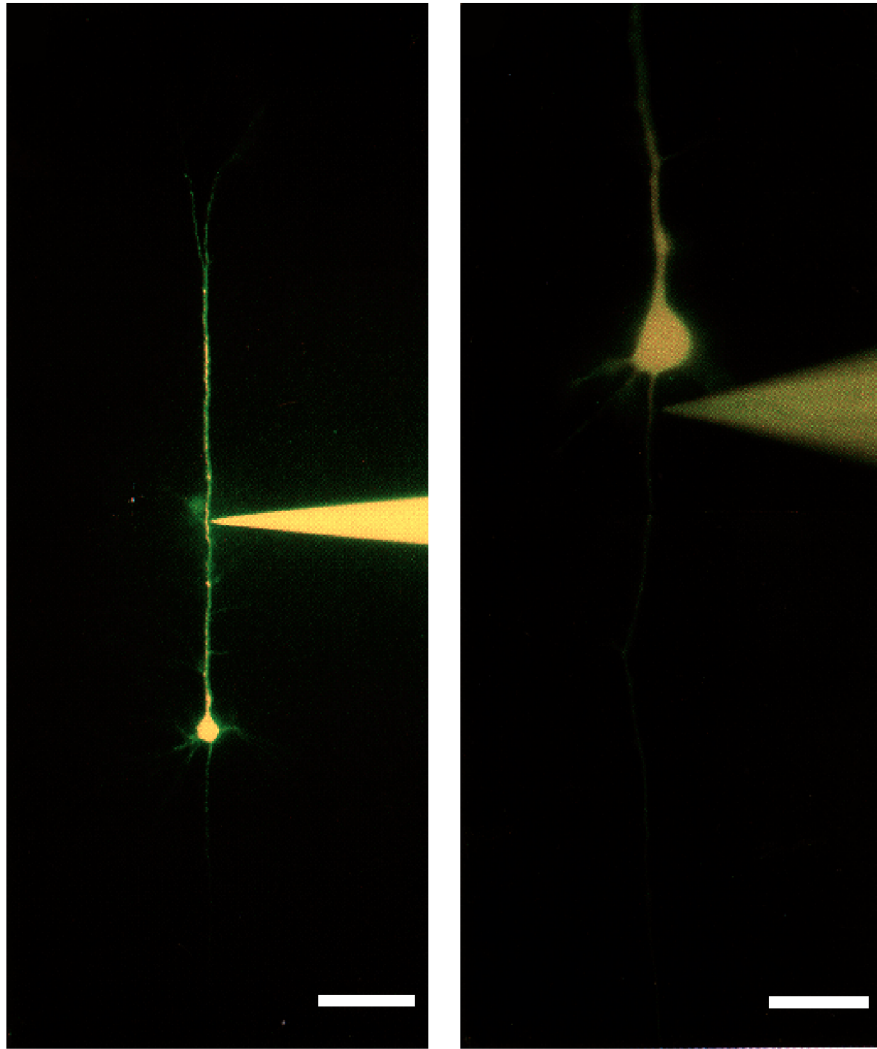

suprathreshold EPSP

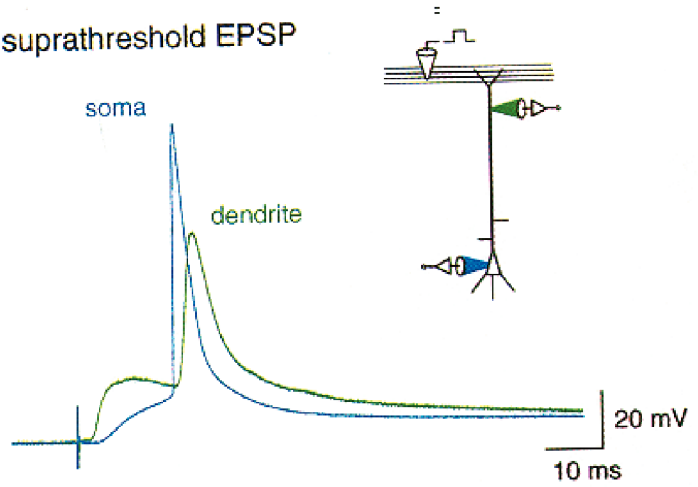

$G_L = 100$ nSiemens $G_{Na-P} = 10$ nSiemens

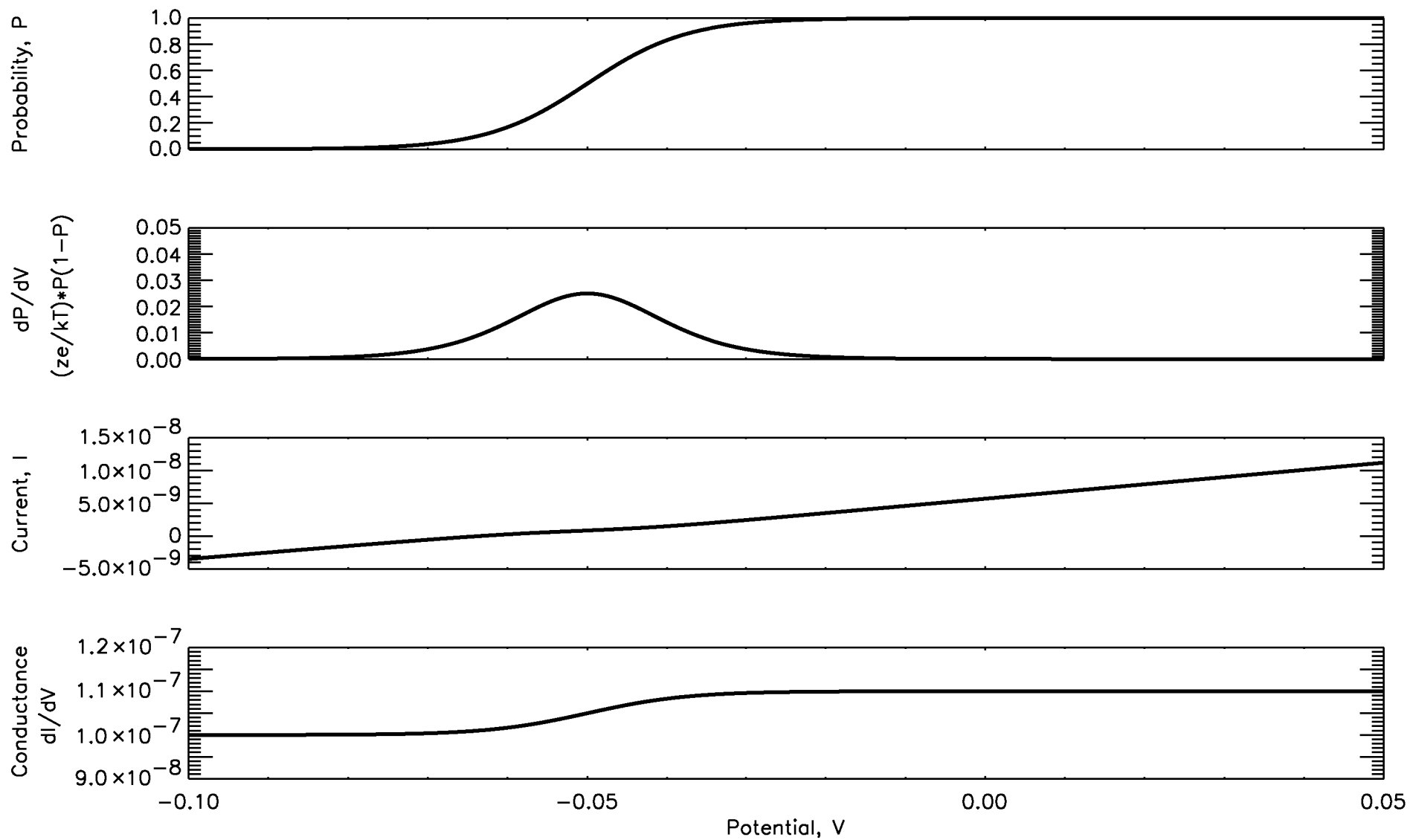

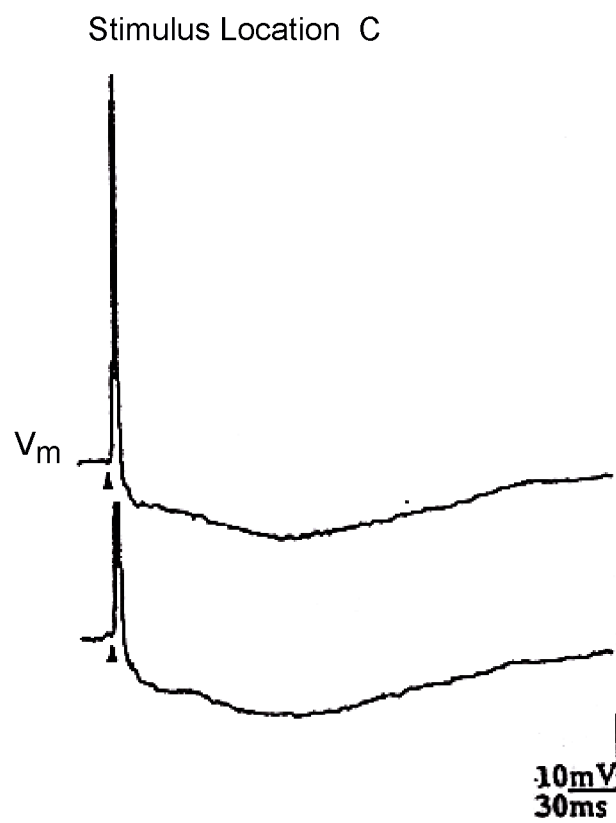
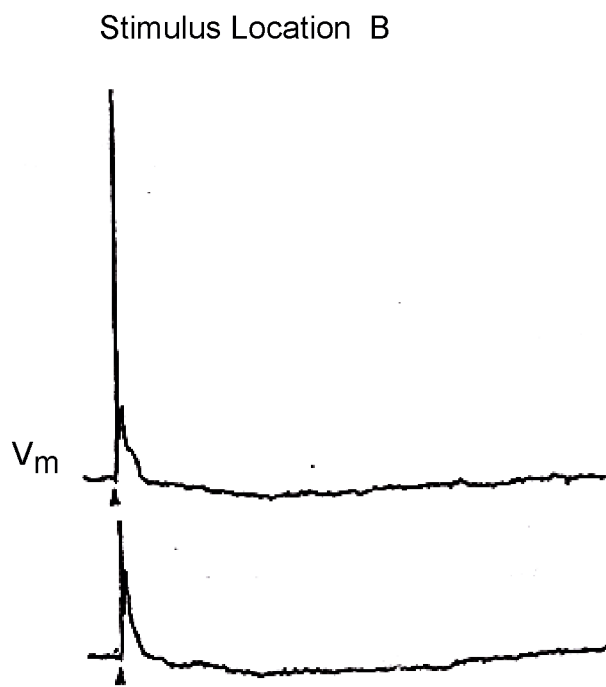
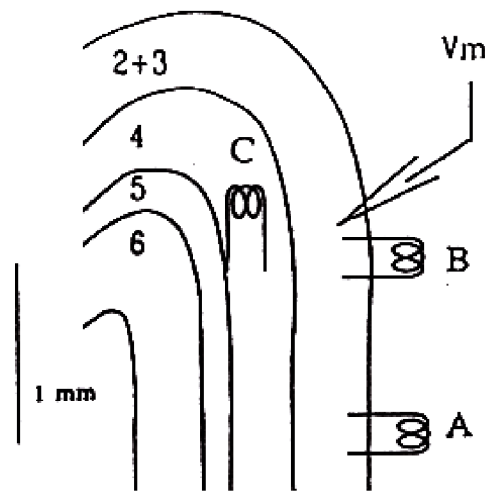
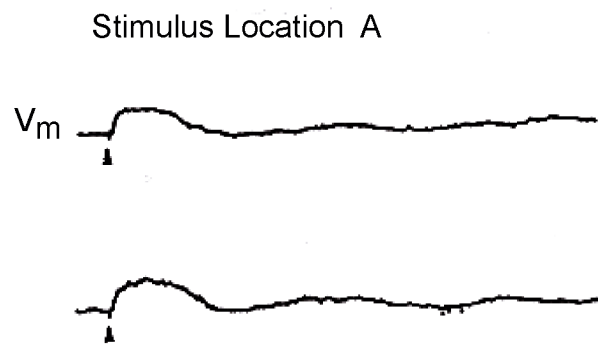

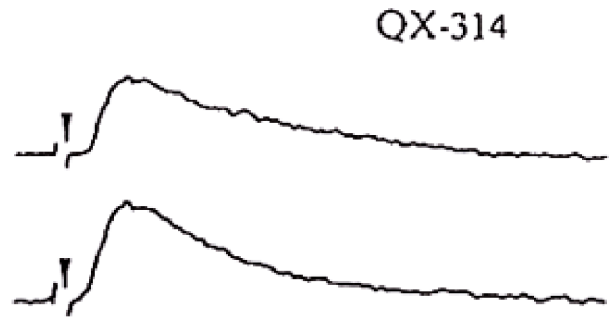
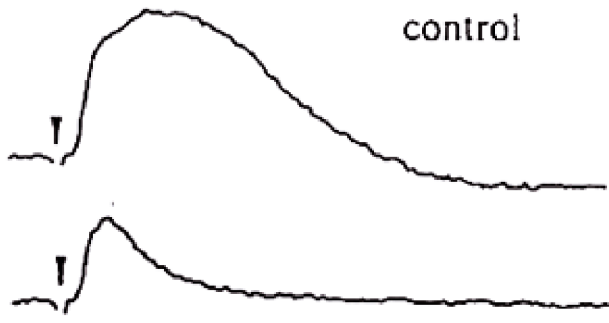

5 mV
20 ms

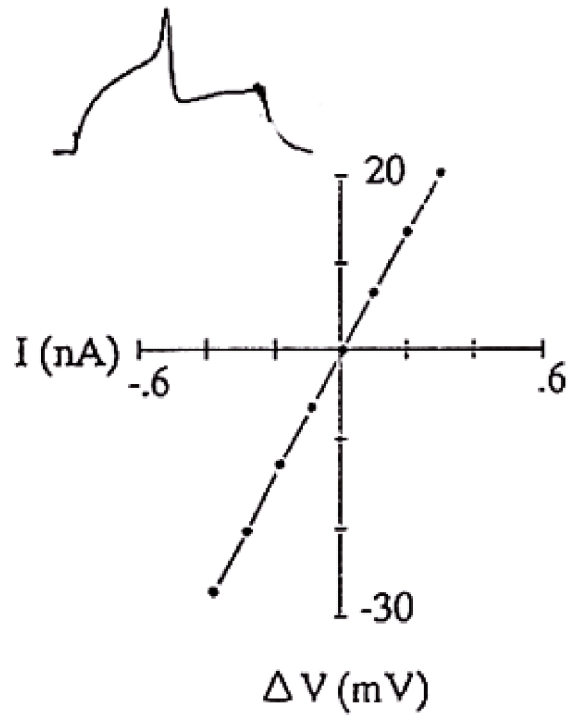
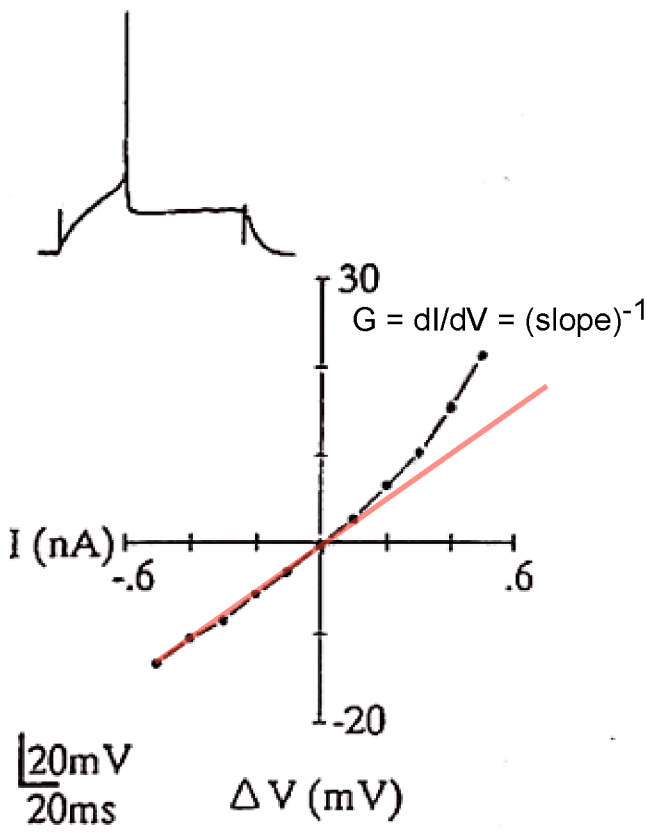

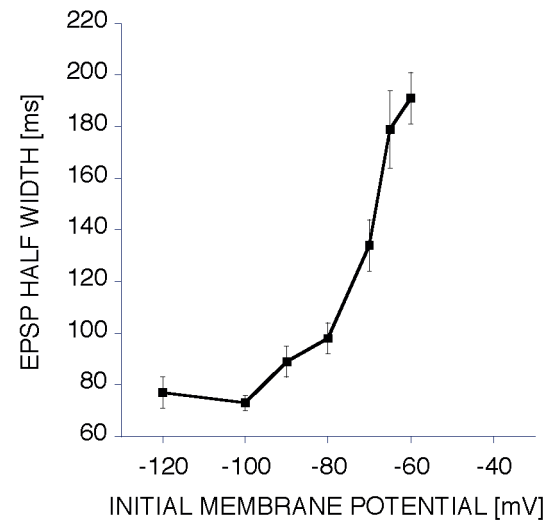
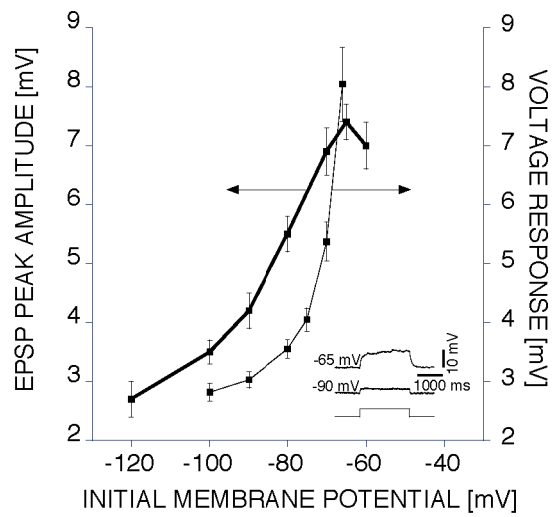
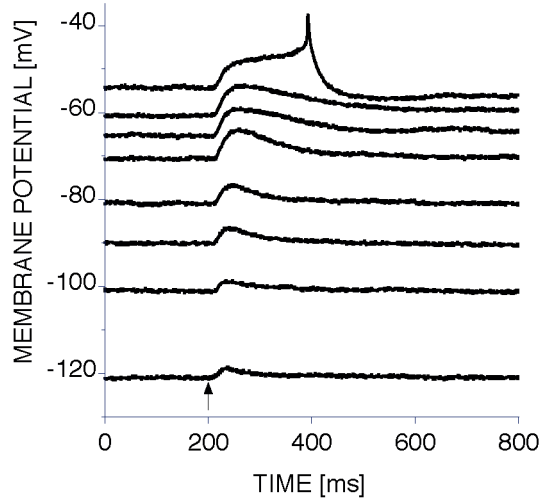

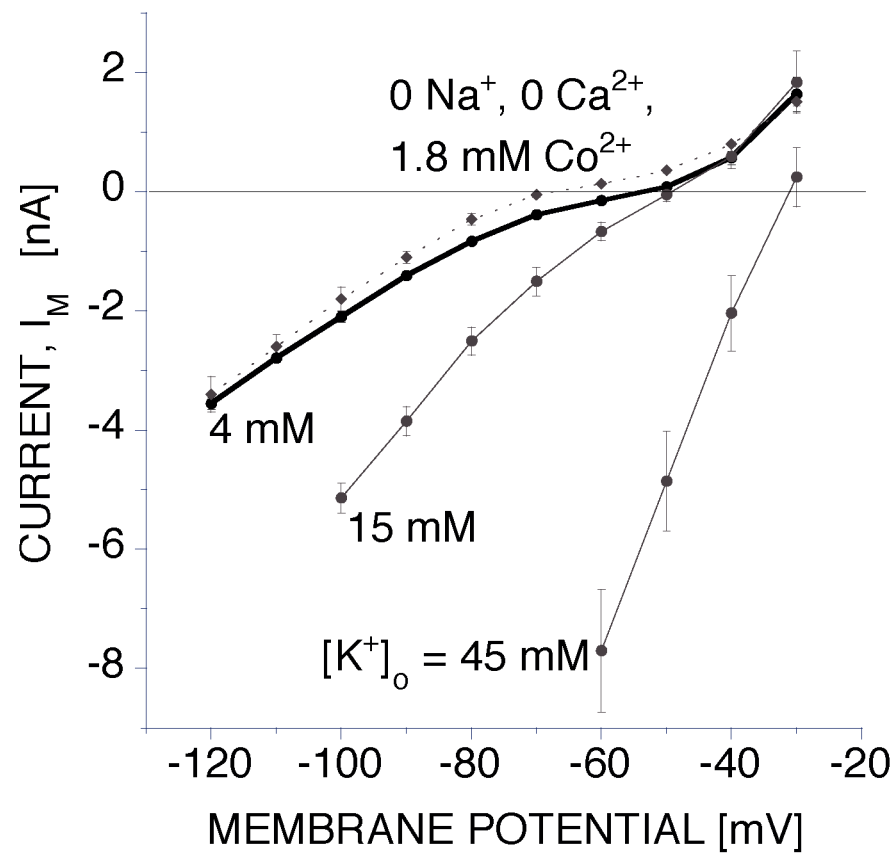
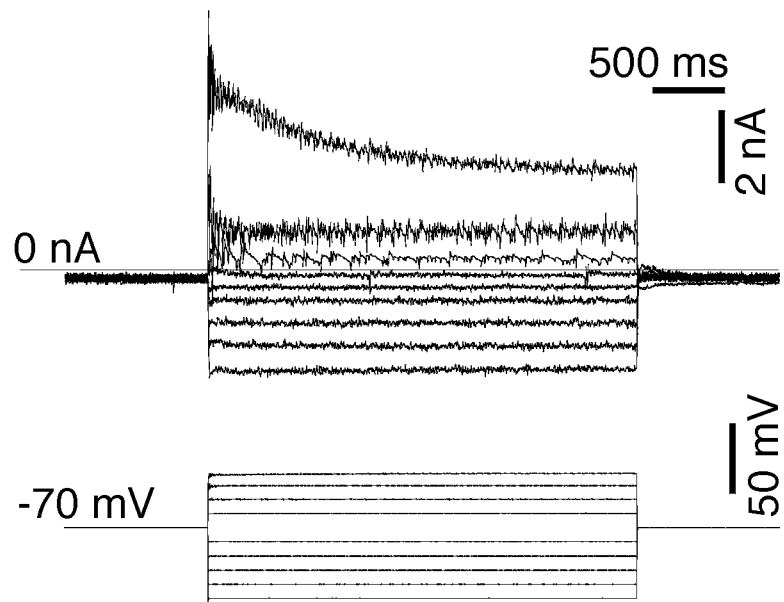

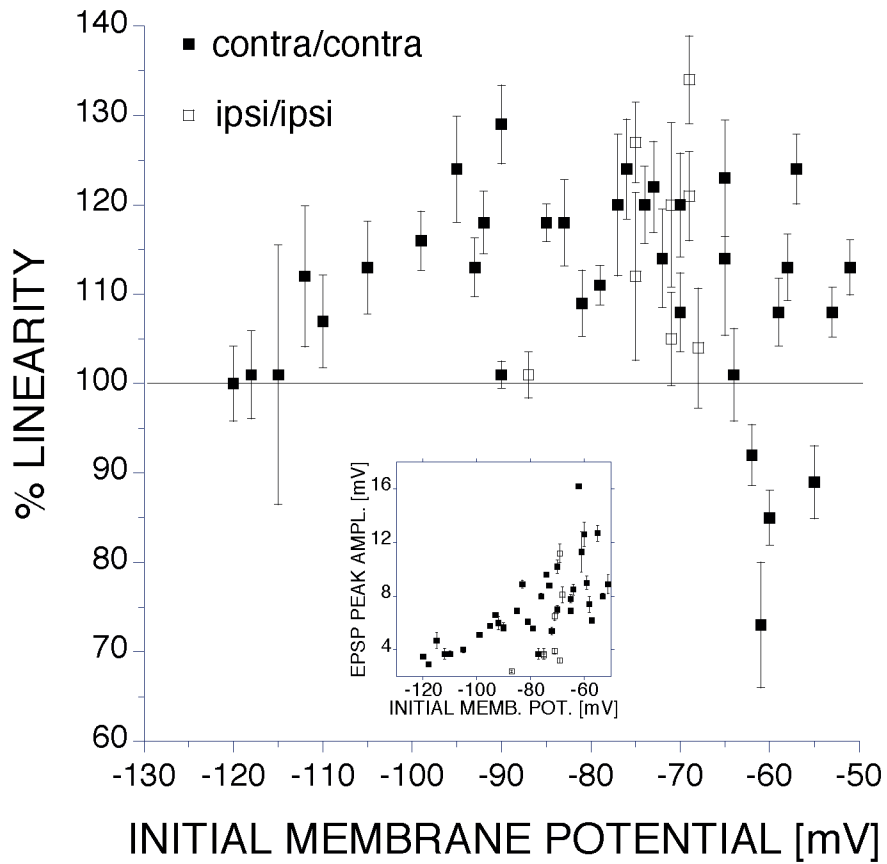
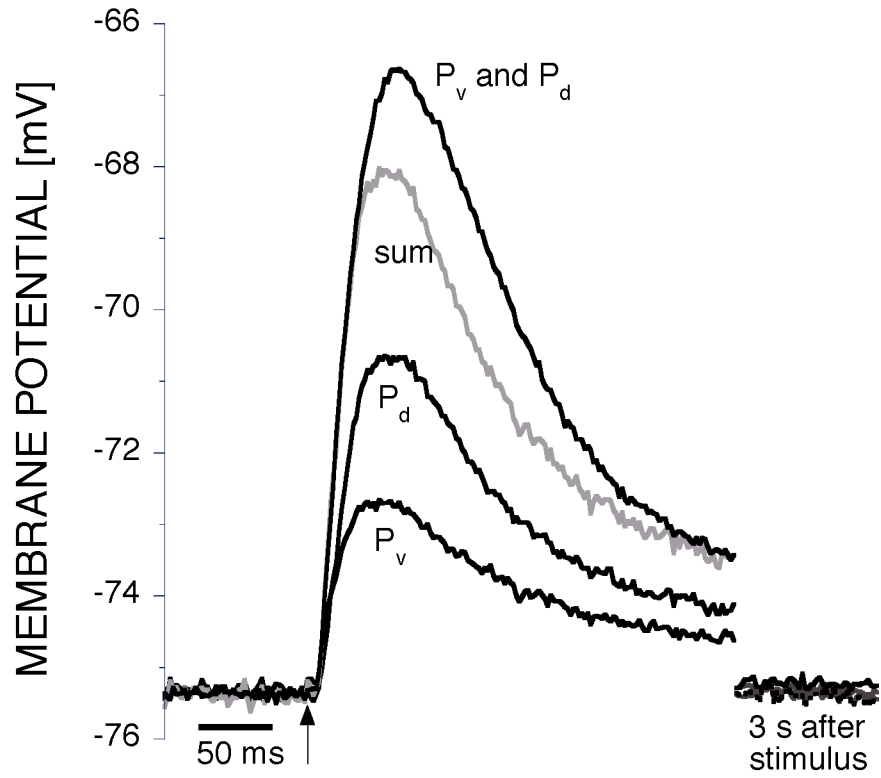

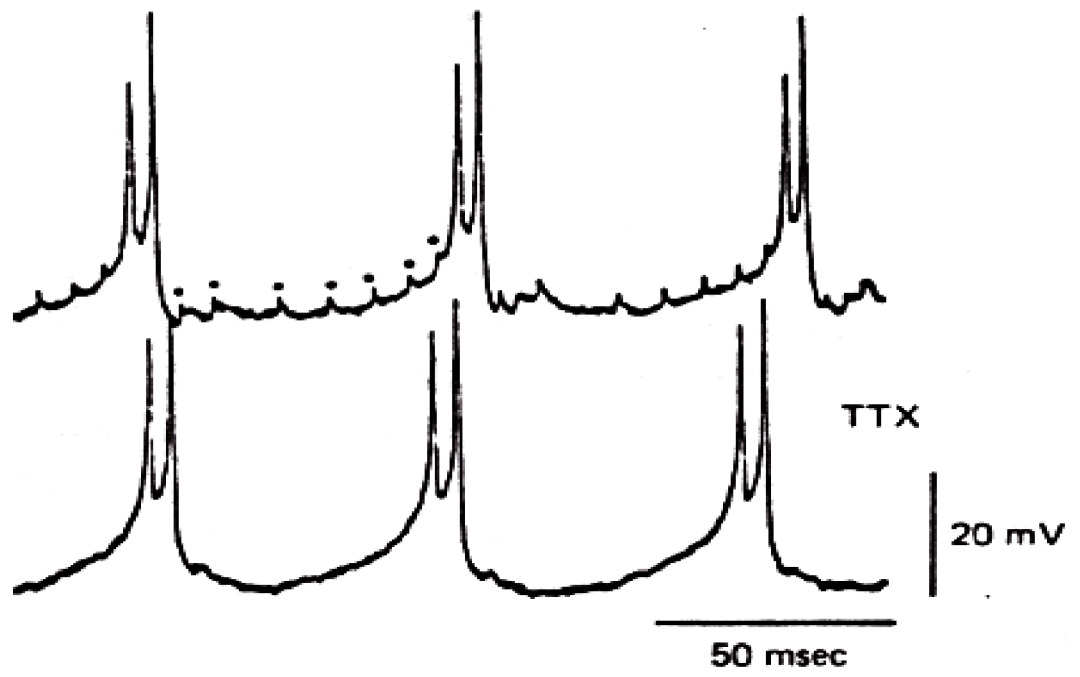
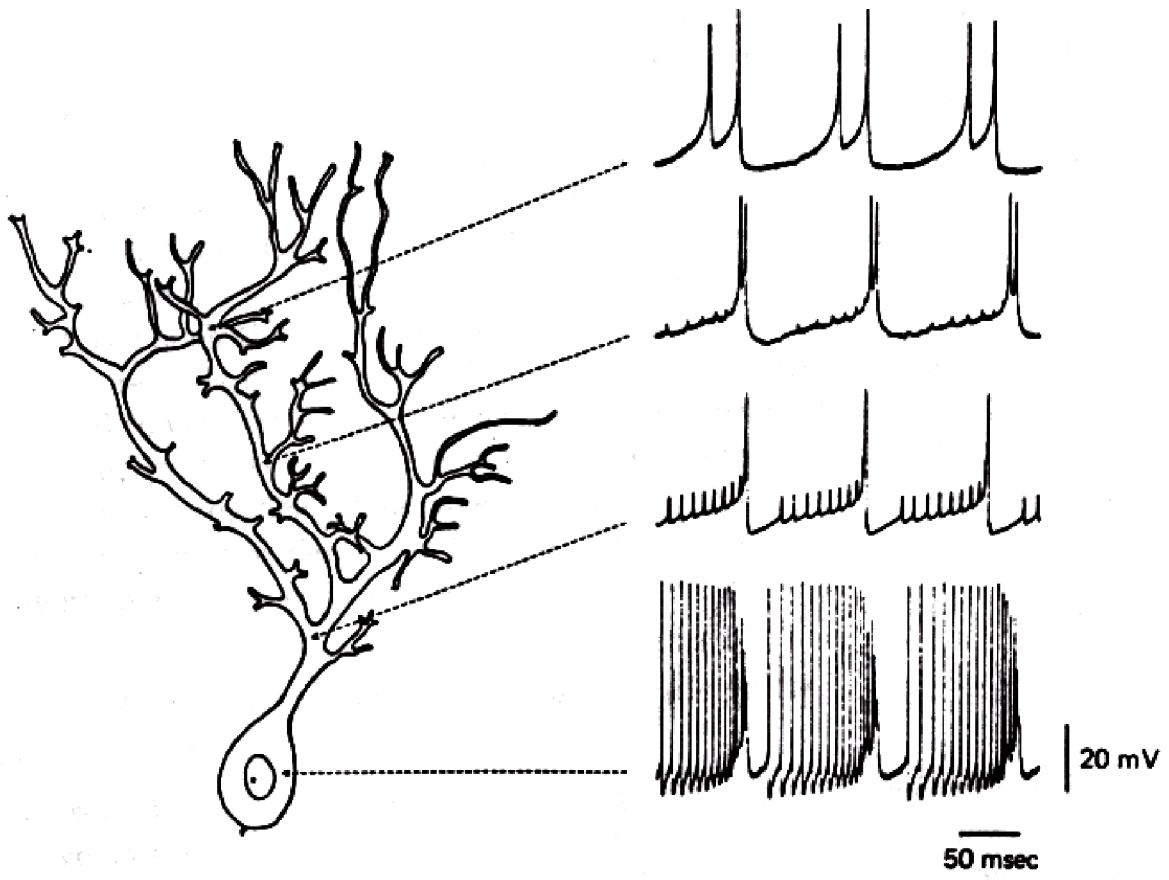

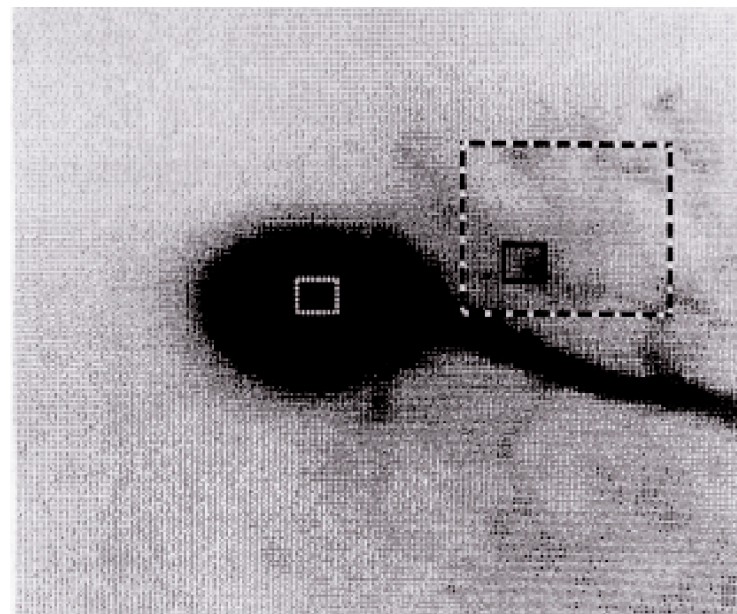
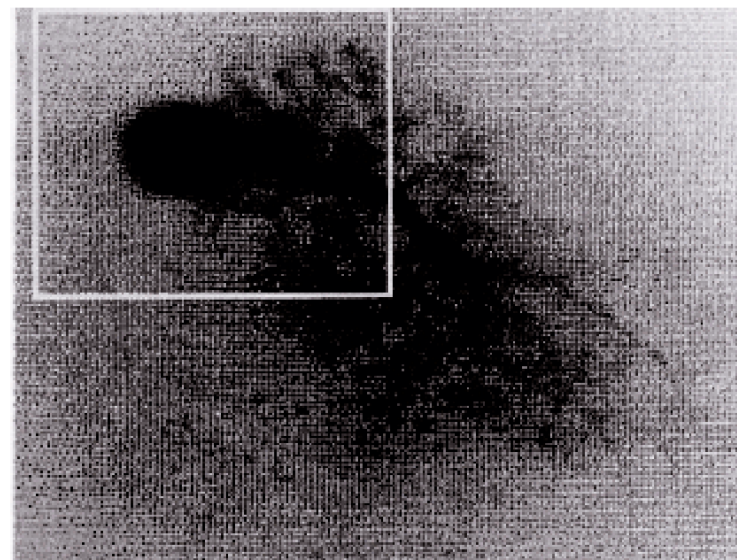
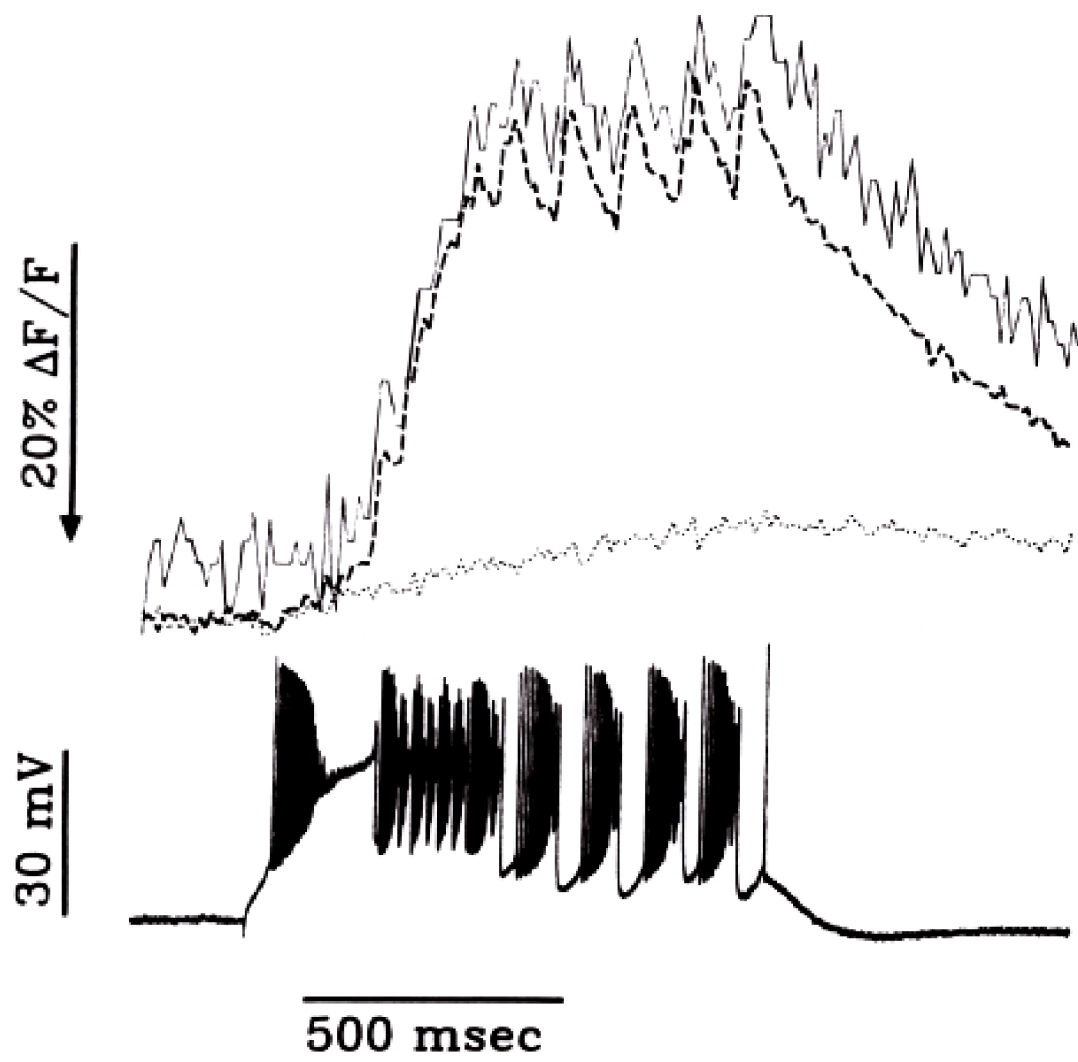

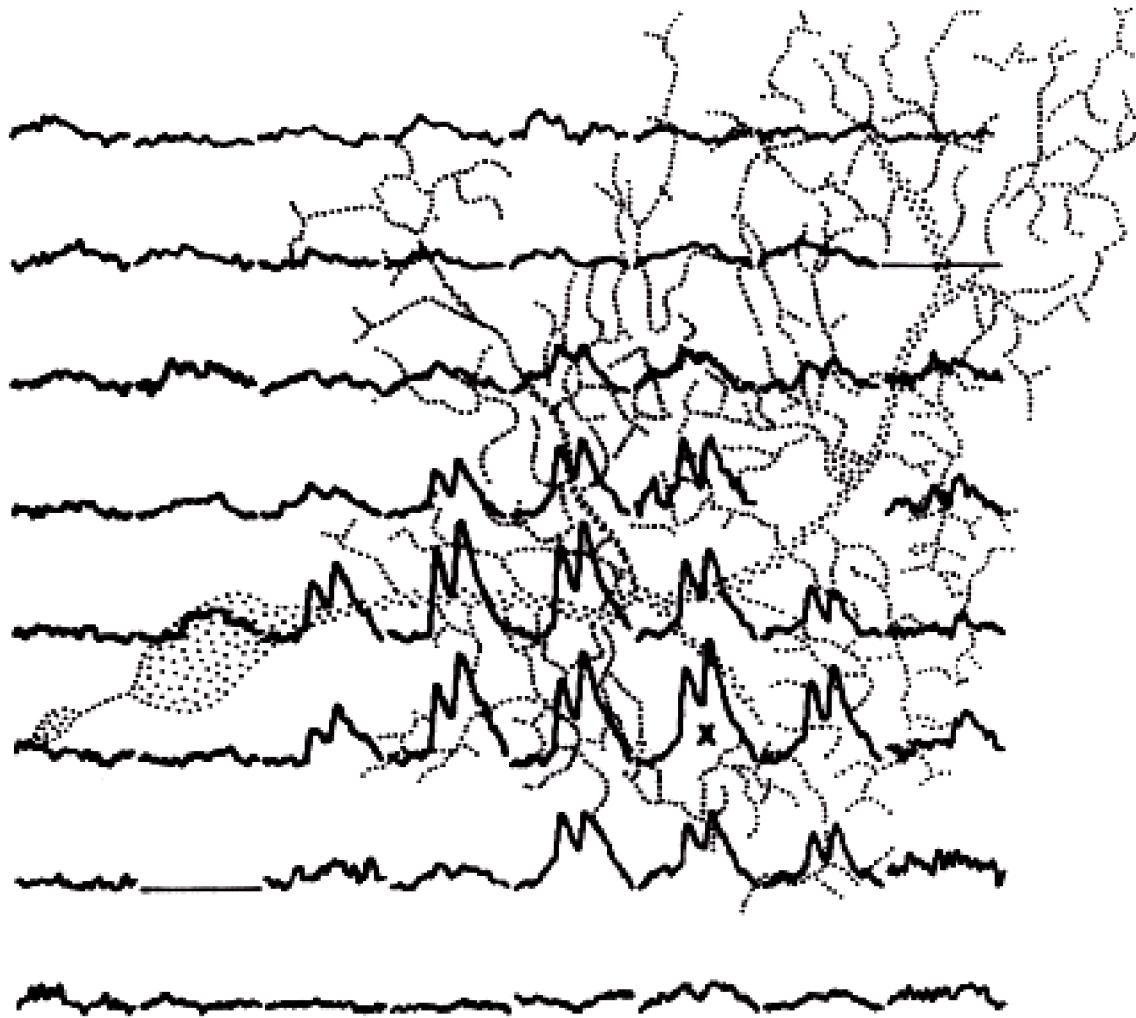

250 ms
31 μ m

